



Valves made of gunmetal and stainless steel

➤ Quality that makes planning easy



KEMPER

Table of contents



▶ Stop and distribution valves

In a multitude of variations, with proven sealing technology on ball and spindle. You will find the suitable valve at KEMPER - for the one-family house and for large buildings - and the matching fitting too.

▶ Protection and regulating valves

Suitable solutions for protecting drinking water based on DIN EN 1717. Dependable, safe and technically sophisticated packages. With stable protection functions for long-lasting reliability.

▶ Hygiene system KHS for warm water and cold water

In warm water, KEMPER regulating valves guarantee the hydraulic compensation for drinking water distribution and circulation. In cold water, use as intended is achieved through forced flow and targeted flushing measures.

▶ 'UP-plus' concealed valves

Flexible in function and design. The widely assorted KEMPER ,UP-plus' range gives planners and plumbers a free hand when selecting materials and design, function and assembly, connection and coupling engineering.

▶ Stop-valve water meter range

With the 'fast, secure' KEMPER stop-valve water meter combination and premounted water meter units made of gunmetal, installing concealed valves and water - meter housings saves time and money.

▶ Frost-proof outdoor valves

With ice-cold advantages. Frost-proof outdoor valves from KEMPER guarantee automatic protection against frost and water damage through automatic drainage. The often forgotten shut-off and drainage then becomes superfluous.

▶ System valves

KEMPER system valves provide material and cost savings through permanently integrated press-fit connections for the Geberit 'Mepla', 'Sanha', 'mapress', 'sanpress' und 'profipress' system valves.

▶ Stainless steel

For premium demands in drinking water installations, KEMPER offers a large selection of stainless steel valves. Technically perfect, inside and out. And matching to that, the general purpose connection facilities to all common piping systems.

▶ Quality that makes planning easy:

KEMPER valves: the large range in a modular system - made entirely of gunmetal and stainless steel.

Photographs partially include optional accessories. We reserve the right to make technical



- KEMPER valves made of gunmetal and stainless steel
- KEMPER lip seals

1

- KEMPER gunmetal - the material

2

- Stop and distribution valves

3

- Protection and regulating valves

4

- Hygiene system KHS for warm water and cold water

5

- 'UP-plus' concealed valves

6

- Stop-valve water meter range

7

- Frost-proof outdoor valves and 'Tresor' wall cupboards

8

- System valves

9

- Stainless steel valves – noble

10

- Shipbuilding / Industrial valves

11

- Insulating

12

- Contact person / Training

13



Valves made of gunmetal and stainless steel

Corrosion-resistant, maintenance-free and easy to install: The trademark quality of the KEMPER sanitary valves is esteemed by our distribution partners just as highly as by expert planners and plumbers. One of our major focuses is to technically improve our valves, especially combination module valves and valve types. This is where KEMPER is way ahead of the game. Our customer-focused marketing guarantees you service that will certainly satisfy your demands.

The European brand

You can find your contact person onsite and in the Olpe / Germany headquarters on page 70.



Our large range of valves

- Stopping – Protecting – Regulating
- Concealed valves
- With matching insulating shells
- Flanges, fittings and accessories
- Frost-proof outdoor valves
- Stop-valve water meter range





Advantages at a glance

- Corrosion resistant; made of gunmetal according to DIN 50930/6 (EN 1982) and stainless steel
- With self-lubricating EPDM lip seals that can be replaced under pressure as a maintenance-free spindle sealing
- DVGW, SVGW, ÖVGW, KIWA, WRAS and soundproofing certificate
- Stagnant-zone-free
- Connection facilities for all common piping systems

Gebr. Kemper GmbH + Co. KG, Olpe / Germany

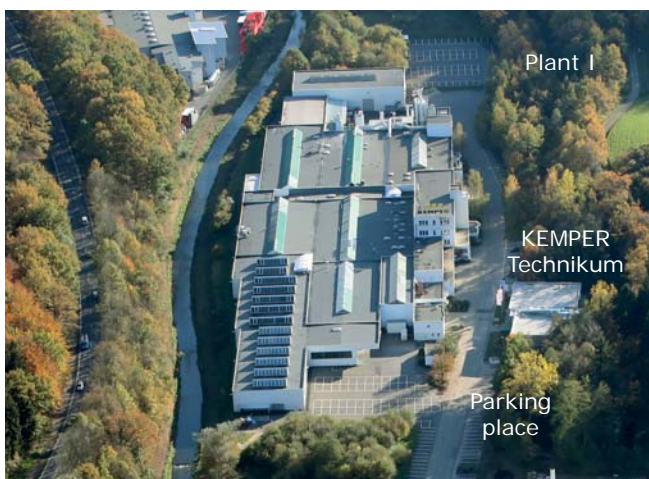



Quality awareness

In each individual step of our fabrication process, our products are tested, appraised and put through strict tests. At KEMPER, our employees live quality as an obligation. That means products emerge that you can count on, permanently.

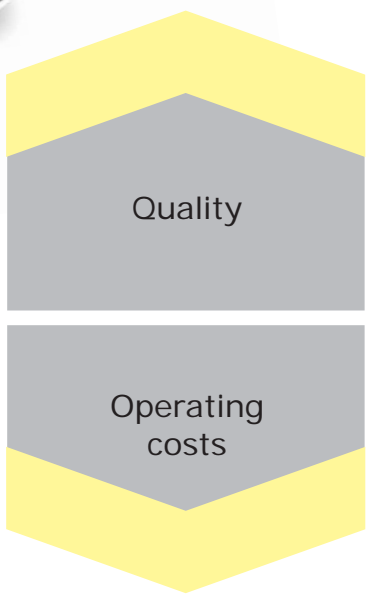

KEMPER valves Protection and maintenancefree for decades

Many promise protection for years. But only a few guarantee protection for decades. Starting immediately, you can specify KEMPER protection in your delivery specification texts: „... With self-lubricating EPDM lip seals that can be replaced under pressure as a maintenance-free spindle sealing“



Protection is good. Long-term protection is better

Protection and freedom from maintenance for decades – there is no better reason for recommending KEMPER valves with the self-lubricating EPDM lip seals during bidding. Valves from KEMPER provide many value added benefits when compared to other valves:

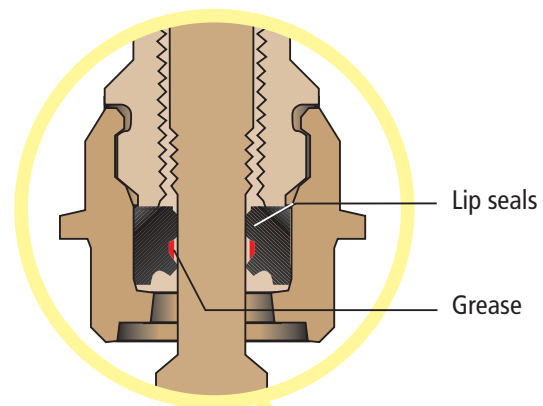

KEMPER – stagnant-zone-free head part - for us, just old hat

- Absolutely stagnant-zone-free, making them hygienically safe because microbiology is impossible
- With self-lubricating EPDM lip seals that can be replaced under pressure as a maintenance-free spindle sealing
- Voluminous, self-lubricating, lower lying lip seal separates the spindle thread
- Shock resistant and ergonomic, easily reachable handwheel
- High-quality, dimensionally stable special seat sealing with high return force and extreme pressure and temperature stability
- Head-part and housing material made completely of gunmetal and corrosion resistant against aggressive water
- Head part can be completely replaced and combined with standard valves for repairs
- With DVGW and sound insulation
- Materials compliant with CDW recommendations
- 10 year guaranty specifically for gunmetal stop valves, Figure 173



KEMPER Gunmetal

KEMPER gunmetal - suitable for all types of drinking water

Old bronze ship's bells, artistic wine casks and other finds from the Bronze Age (from approx. 6000 BC.) impressively prove this material's unusual durability. And that's even true when the witnesses of this creative epoch have been laying in salty sea water for thousands of years. The gunmetal cast by KEMPER is a material closely related to bronze (copper and tin) and is extremely well suited for use in domestic water engineering, especially in drinking water and heating installations.

Gunmetal is a material that can be used for all kinds of drinking water. The emission of alloying elements lies within the frame of the German drinking water regulations (German abbreviation: TrinkwV).

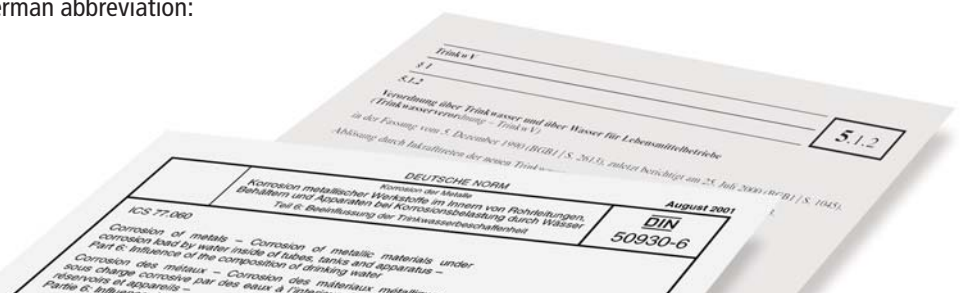

- Due to its high Cu content, gunmetal has low dezincification
- According to the Drinking Water Quality Ordinance, gunmetal can be used without restrictions in all water qualities
- Gunmetal is especially corrosion resistant
- Gunmetal is extracted from recycling materials (old valves and components) without any loss of quality, protecting the environment and conserving resources
- That means gunmetal provides you with security! Now and in the future!

KEMPER gunmetal – The ideal valves and plumbing material

According to EN 1982 (modified in accordance with DIN 50930/6), gunmetal is a standardised valve and plumbing material that, with its manifold applications is especially suited to sanitary in-

stallation technology, e.g., as a valve material, as a fittings material for piping system components and as a construction material in water, filtering and recycling engineering.



KEMPER gunmetal free of stresscorrosion cracking and dezincification

KEMPER gunmetal is corrosion resistant and safe against the most frequent and most dangerous types of corrosion, stress corrosion cracking and dezincification. Stress corrosion cracking can occur when components made of brass are installed under a

high degree of tensile stress. At the same time, it is insignificant whether the occurring tensile stresses are caused by the component manufacturing process, e.g., pressing, or by faulty installation, e.g., over-hemping a thread.

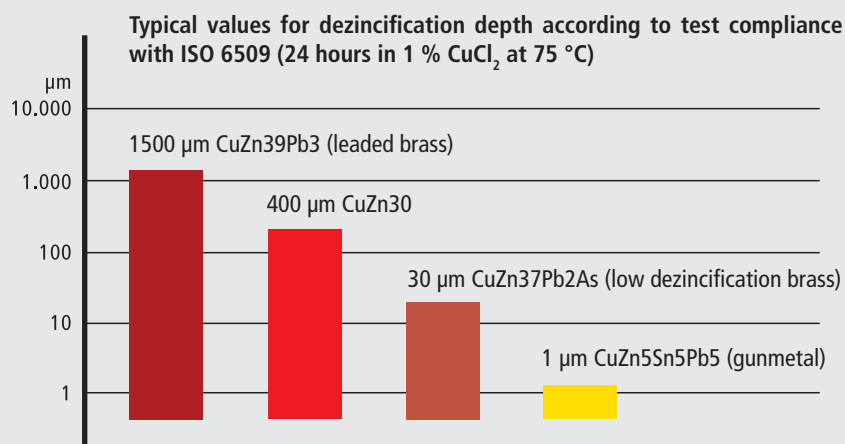

KEMPER gunmetal – can be combined with all known plumbing materials

Gunmetal can be used universally and can be combined at will with all known installation materials, e.g. in piping system coupling technology with copper, stainless steel, galvanized steel and with plastics. Gunmetal can be processed very well and is used in the most various kinds of press-fit connection systems.





KEMPER Stop and distribution valves

Secure against corrosion, perfect in coupling technology

KEMPER stop and distribution valves in various versions, made completely out of gunmetal. With proven sealing technology on the ball and spindle. KEMPER's wide range comes in a modular system - for single-family houses or major projects - and the matching connection to boot.

- Flanges or fittings as system
- valve 'sanpress' and 'profipress', 'mapress', 'Mepla' and 'Sanha'

Advantages at a glance

- Completely made of gunmetal, resistant to aggressive water
- With self-lubricating EPDM lip seals that can be replaced under pressure as a maintenance-free spindle sealing
- NIRO seat with high-quality gasket ring
- Stagnant-zone-free
- DVGW and soundproofing certificate, versatile use through country-specific permits
- Connection facilities for all common piping systems

1
2
3
4
5
6
7
8
9
10
11
12
13

KEMPER free-flow stop valve with permanently cast Geberit 'Mepla' connection Figure 190 41



KEMPER free-flow stop valves with permanently integrated press fit 'Sanha' Figure 190 36



KEMPER free-flow stop valves with flange connection Figure 135



KEMPER double distributor Figure V2



KEMPER Water Meter Mounting Accessories



KEMPER water meter mounting accessories Figures 450

- Valves and fittings made completely of gunmetal with integrated length compensation
- Open, adjustable stainless steel bracket
- Wall clearance adjustable from 92 - 132 mm
- Water meter fitting can be sealed
- Various connection variants for every installation situation

With a 10 year guaranty



Be on the safe side. Trust trademark quality from KEMPER - made in Germany, from gunmetal, reliable and proven.



KEMPER free-flow stop valve with flat-sealing external threads Figure 173



KEMPER Protection valves

Install with guaranty

KEMPER protection valves for protecting drinking water in accordance with EN 1717. Reliable, secure and technically sophisticated solutions. Made completely out of gunmetal smooth and soft sealing. With stable protection function for longlasting functional reliability.



KEMPER check valve with shut-off function (RV) for protection Figure 158

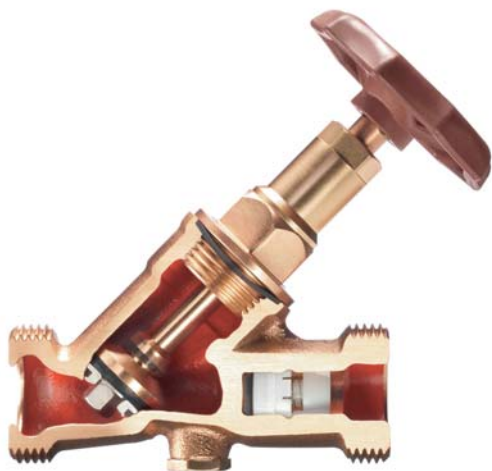

KEMPER check valve with shut-off function (KRV) for protecting and stopping with maintenance free lip seals Figure 145



KEMPER insulating universal shells for all KEMPER free-flow inclined valves Figure 471 10

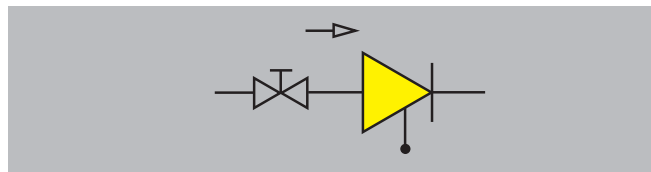

KEMPER Anti-pollution Check-valve EA protects drinking water from non-potable water up to fluid category 2

2

KEMPER Antipollution check-valve

KEMPER anti-pollution check valves with permanently integrated press fit mapress Figure 193 23



KEMPER anti-pollution check valve with permanently integrated press fit Viega Figure 195 31



Advantages at a glance

- Extremely streamlined design which reduces the required opening pressure to a mere 10 mbar (Figure 145, 158, 159)
- Suitable for circulation systems
- With test instruments for prescribed function test on the anti-pollution check valve
- With self-lubricating EPDM lip seals that can be replaced under pressure as a maintenance-free spindle sealing
- DVGW and soundproofing regulations

KEMPER pipe disconnecter CA



Figure 362

Advantages at a glance

- Housing made entirely of gunmetal according to EN 1982
- Interior components made of rustproof stainless steel and high quality plastics
- Easy-to-replace cartridge
- Simple handling

KEMPER pipe disconnecter CA protects drinking water from non-potable water up to fluid category 3

3



KEMPER 'Fill-Matic'

The new KEMPER Heating filling stations



The new KEMPER 'Fill-Matic 3' and 'Fill-Matic 4' permanently and reliably connect the heating plant with the drinking water system. That makes filling and refilling permanently convenient and safe. The integrated safety devices reliably prevent drinking water from the heating plant from getting into the drinking water net-

work. So, heating plants can be protected **without inhibitors** up to fluid category 3 or **with inhibitors** up to fluid category 4 in accordance with European standard EN 1717. In warm drinking water systems, increasing scale build-up hinders the heat transmission and leads to undesired temperature increases on the heat transfer

surfaces. According to VDI 2035-1, softening plants are to be provided in accordance with the capacity or corresponding to the total carbonate for the filling and supplemental water. If the softening plant is required, it can only be implemented using the 'Fill-Matic 4'.

- Comfortable heating plant filling and refilling through a permanent connection
- Safe because standard-compliant and approved
- Compact mounting type by integrating stopping, strainers, pressure reducing valves, manometers and the CA pipe disconnect or BA backflow preventer
- Constant refill pressure through integrated pressure reducing valve
- Connection facility for all common piping systems
- High-quality, in proven gunmetal quality, resistant against aggressive water
- Simple servicing through integrated shut off
- Proven insulation technology according to the requirements made by EnEV, (German Energy Savings Act) Building Material Class 1

'Fill-Matic 3'

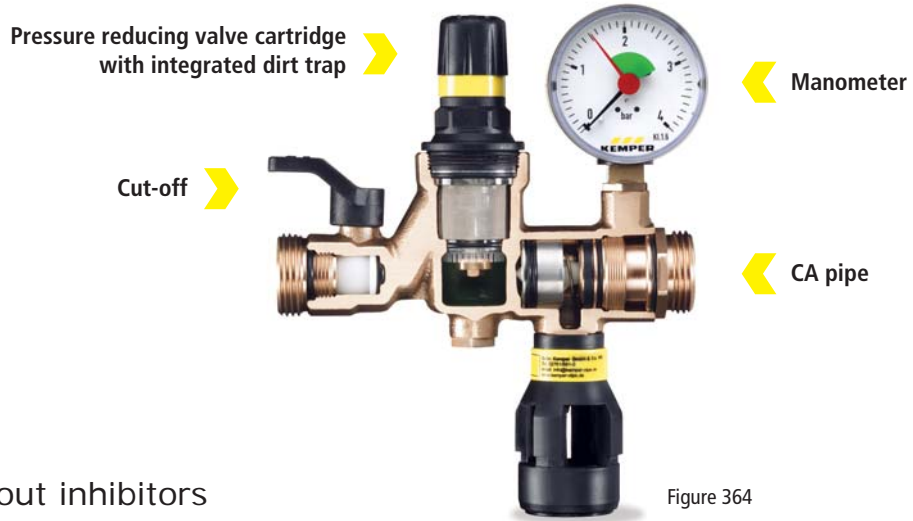

Figure 364



Heating plant without inhibitors

KEMPER 'Fill-Matic 3' heater filling combination CA protects drinking water from non-potable water up to and including fluid category 3

3

'Fill-Matic 4'

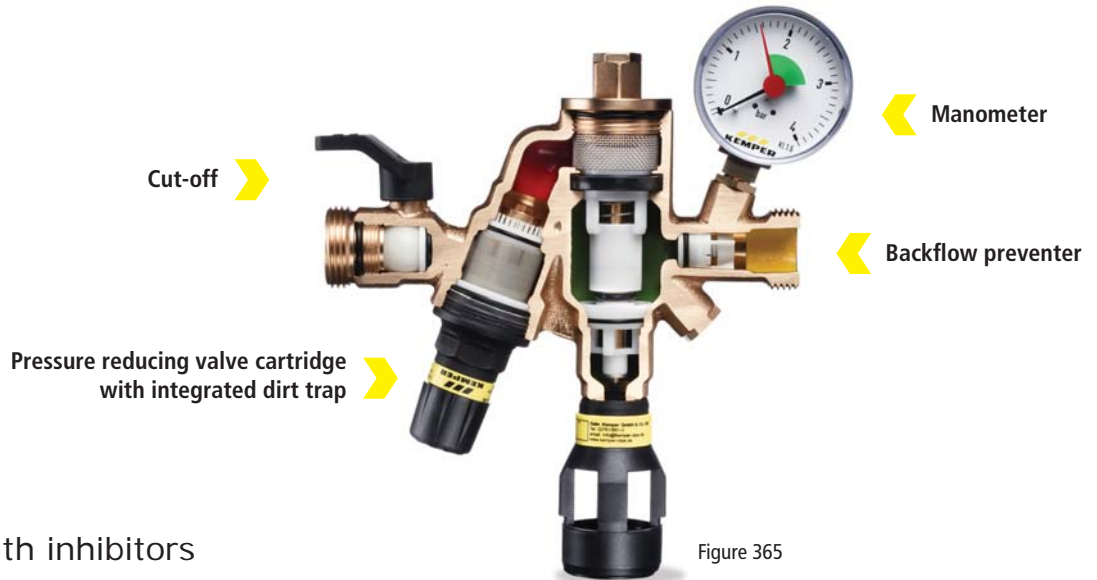

Figure 365



Heating plant with inhibitors

KEMPER 'Fill-Matic 4' heater filling combination BA protects drinking water from non-potable water up to and including fluid category 4

4

Installation example according to EN 1717

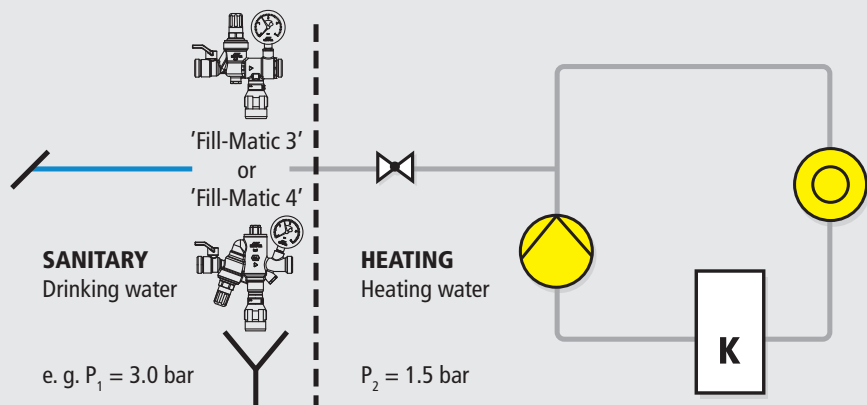



KEMPER 'Protect' Backflow Preventer BA

The new DIN EN 1717

The new DIN EN 1717 stipulates a uniform standard for drinking water installations Europe-wide to protect drinking water from nonpotable water. This standard differentiates the application fields for protection valves and defines the permissible fluid categories. Along with water supply companies, especially the following design engineers and plumbers are exposed to a liability risk.

KEMPER provides you the safe, technically mature solution for that:

The new, patented KEMPER 'Protect' backflow preventer BA protects drinking water from nonpotable water up to and including fluid category 4.

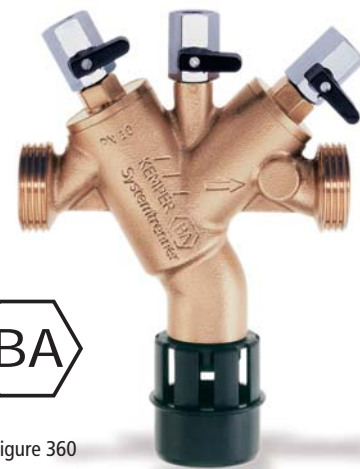

Figure 360

- Price advantage through light weight, short length and integrated dirt trap
- Differential-pressure controlled protection cartridge made from one assembly group contributing to easy replacement for the specified maintenance
- System pressure dependent, no drain valve dripping during pressure fluctuations
- All parts that have contact with fluid (drinking water) made of gunmetal or stainless steel
- Stagnant-zone-free
- Installation of the backflow preventer BA under the highest possible water level
- DVGW-/SVGW certificate

Simple maintenance:
Trust is good,
control is better



According to EN 1717, there is an obligation to perform regular maintenance for the BA backflow preventer. Accordingly, an annual maintenance contract is to be concluded between the operating company and the plumber.

The integrated dirt trap and the differential-pressure controlled protection cartridge are easily removed by opening the head part.

The output-side anti-pollution check-valve can also be replaced as necessary by opening the head-part with a twist of the wrist. That makes maintenance fast and effortless and is done in a jiffy.

The three chamber system

Technically mature, that's why it's so safe: The KEMPER 'Protect' - backflow preventer BA is based on an ingenious three-cham-

ber system with precompression, medium pressure and back pressure zones. The differential-pressure controls in the input

protection cartridges and the output anti-pollution check-valve (RV) ensure reliability and a high degree of protection.

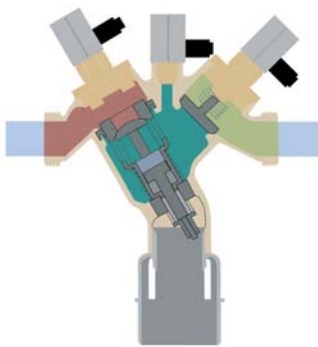

I. Neutral position (Under operating pressure)

If no water is being withdrawn, the input and output side RV and the drain valve are closed.

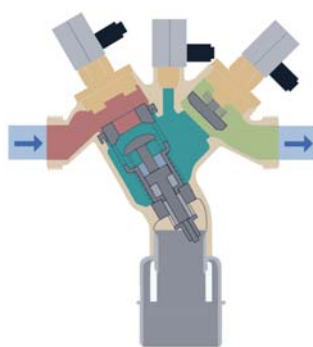

II. Flow position

If water is being withdrawn, the input and output side RV and the drain valve are closed.

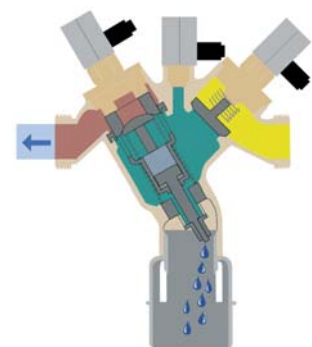

III. Isolation position

During backsiphonage, the input side pressure falls. If the pressure difference between the precompression and medium pressure chamber is only a bit over 0.14 bar, the input side RV and the drain valve closes.

KEMPER backflow preventer BA protects drinking water from non-potable water up to fluid category 4



1
2
3
4
5
6
7
8
9
10
11
12
13

The application areas

According to EN 1717, National Appendix, the following devices and withdrawal points are to be protected by a backflow preventer BA:

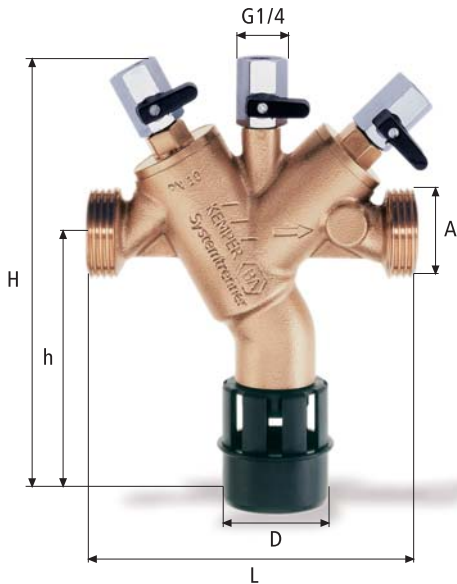

- Swimming and bathing pools with preparation and disinfection
- Chemical admixture appliance (disinfection agent or fertilizer)
- Chemical cleaning appliance
- Printing shop, reproduction plant, photograph operation, film developing machine
- Bath lifter, openings and functional parts above bathing edge
- Galvanic bath
- Sterile water, production with disinfection
- Heater filling appliance (water with inhibitors)
- High-pressure cleaner with chemical admixture
- Laboratory table, chemical lab
- Softening/denitrification plant, formalin disinfection (dialysis)
- Sterilizers for carcinogenic material
- Gas developer, e.g. acetylene
- Boot washer

Installation according to EN 1717*

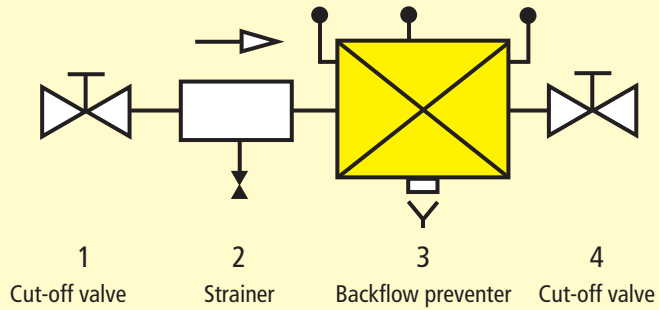

KEMPER 'Protect'
Ideal operating values with low weight and short mounting types

DN	A	H (mm)	h (mm)	L (mm)	D (mm)	Weight (kg)	Operating pressure	Operating temperature	Rated flow at 1 bar pressure loss
15	G 3/4	220	138	135	50	1.5	PN 10	max. 60 °C	3.3 m³/h
20	G 1	220	138	140	50	1.55	PN 10	max. 60 °C	3.5 m³/h
25	G 1 1/4	220	138	146	50	1.65	PN 10	max. 60 °C	3.5 m³/h
32	G 1 1/2	310	178	228	70	5.1	PN 10	max. 60 °C	14 m³/h
40	G 1 3/4	310	178	226	70	5.2	PN 10	max. 60 °C	15 m³/h
50	G 2 3/8	310	178	230	70	5.3	PN 10	max. 60 °C	15 m³/h

Planning goal:
Protection of the
drinking water,
risk minimization

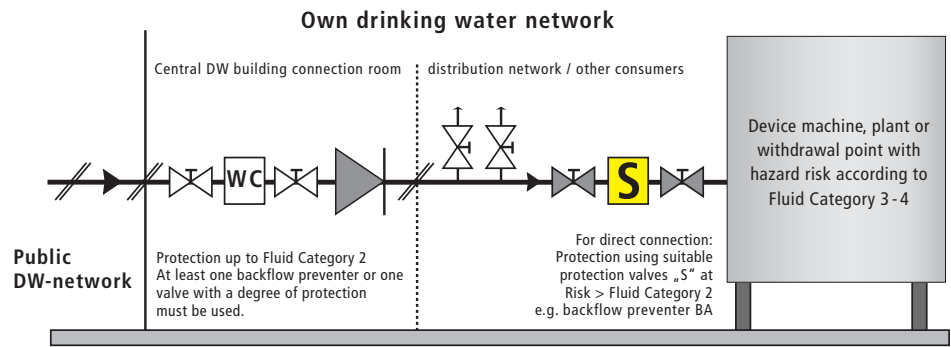

EN 1717

Protection matrix of the protection devices

EN 1717							
		Protection device	Can be used to protect the Protection device Fluid Categories				
Group	Type	Description	1	2	3	4	5
A	A	Unhindered, free drainage	x	•	•	•	•
	B	Free drainage with non-circular overflow (unrestricted)	x	•	•	•	•
	C	Free drainage with ventilated immersion pipe and overflow	x	•	•	–	–
	D	Free drain with injector	x	•	•	•	•
	F	Free drain with circular overflow (restricted)	x	•	•	•	–
	G	Free drain with overflow confirmed with trial with under-pressure	x	•	•	–	–
B	A	Pipe disconnector with controlled medium pressure zone corresponds to backflow	•	•	•	•	–
C	A	Pipe disconnector with different, non-controllable pressure zones	•	•	•	–	–
D	A	Pipe ventilator in throughpass	o	o	o	–	–
	B	Back siphonage Type A2 with movable parts	o	o	o	o	–
	C	Back siphonage Type A1 with constant connection to atmosphere	o	o	o	o	o
E	A	Controllable anti-pollution check-valve	•	•	–	–	–
	B	Non-controllable anti-pollution check-valve	Only for certain household uses				
	C	Controllable double anti-pollution check-valve	•	•	–	–	–
	D	Non-controllable double anti-pollution check-valve	Only for certain household uses				
G	A	Pipe disconnector, not flow-controlled	•	•	•	–	–
	B	Pipe disconnector, flow controlled	•	•	•	•	–
H	A	Hose connection with anti-pollution check-valve	•	•	o	–	–
	B	Pipe ventilator for hose connections	o	o	–	–	–
	C	Automatic changer	Only for certain household uses				
	D	Pipe ventilator for hose connections, combined With anti-pollution check-valve (valve)	•	•	o	–	–
L	A	Pressurized ventilator	o	o	–	–	–
	B	Pressurized ventilator, combined with downstream anti-pollution check-valve	•	•	o	–	–

Gen. note: Setups with atmospheric ventilation (e.g. AA, BA, CA, GA, GB,...) must not be installed if there is any risk of flooding.

- Covers the risk and/or protection valves permitted
- Does not cover the risk and/or protection valves not permitted
- o Covers the risk only if p = atm
- x not applicable

KEMPER 'Protect' Backflow Preventer BA with flange connection

The secure solution in large nominal widths from DN 65 to 150



Figure 361

- Housing made completely from stainless steel, interior stainless steel and gunmetal
- Maintenance friendly, all functional parts easily accessible
- Lightweight
- With flange connection on both sides
- With controlled isolation
- DVGW-/ SVGW permit, others on request

Fluid categories according to EN 1717

Category	Definition	Examples	Possibly higher category
Category 1	Water for human consumption that is taken directly from a drinking water installation.	Drinking water, water under high pressure, temporary cloudiness through air bubbles	
Category 2	Fluid that does not represent any risk to human health. Fluids that are suitable for human consumption including water from a drinking water installation that can exhibit a change in taste, odour, colour or temperature (heating or cooling).	Coffee, tea, iron bacteria, stagnating drinking water in the drinking water system (a), cooled drinking water, steam (in contact with food), sterile water, demineralised water, cooking foodstuffs, washing fruits and vegetables, treated drinking water (b)	
Category 3	Fluids that present a health hazard for humans through the presence of one or several less toxic substances. (c)	Rinsing water for tableware and kitchen equipment, heating water without additives, flushing cistern water, Water + surface-active agents (c), Softened water (softening plants) (c), Water and corrosion protection agents (c), Water + anti-freeze additive (c), Water and algicides (c), Water and detergent (c), Water and disinfectants (c), Water and coolants (c), Washing fruits and vegetables (d) (Food processing plants)	X X X X X X X X
Category 4	Fluids that present a health hazard for humans due to the presence of one or several toxic or especially toxic substances or one or more radioactive, genotoxic or carcinogenic substances.	danger to life). (e.g. hydrazine, lindane, insecticides)	
Category 5	Fluids that present a health hazard for humans due to the presence of sicknesses that can be transmitted through microbial or viral pathogens (contamination,	Hepatitis viruses, salmonellae, colibacillus, Washing machine water, swimming pool water, Water for animal drinking, WC water	

(a) Some substances can increase the risk (temperature, materials)
 (b) Treated drinking water inside of buildings (excepting the device)
 (c) Classification between Categories 3 and 4 is fundamentally LD₅₀ = 200 mg/kg body weight according to EU-Directive 93/92 of 23-Apr-93
 (d) Category 5 for das prewashing and washing water, Category 3 for rinsing water

KEMPER Differential manometer for backflow preventer BA

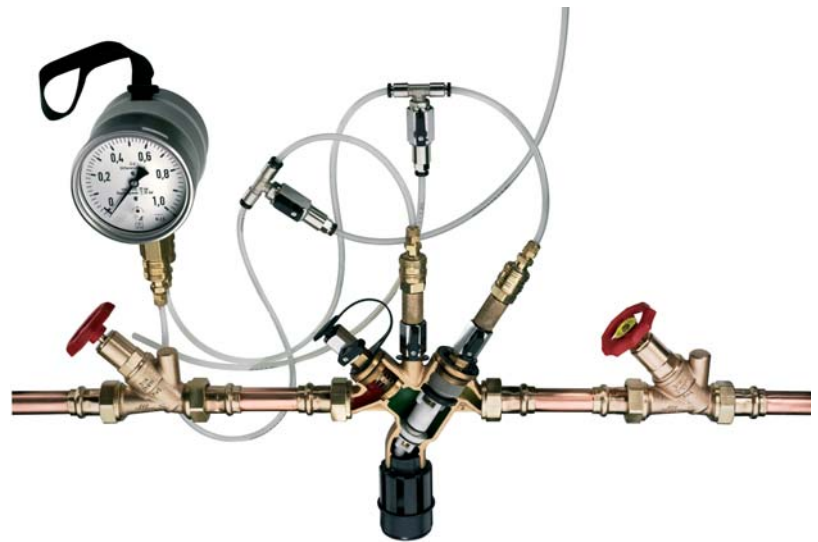

- For the prescribed annual maintenance according to EN 12729
- For checking the functional safety of the backflow preventer
- To determine the differential pressure between forward pressure and mediumpressure chamber

KEMPER Differential manometer



Figure 360 99

- Membrane spring differential-pressure manometer (display up to 1 bar differential pressure)
- With premounted pressure hoses
- With ball valves for bleeding and targeted pre-compression reduction
- Including adapters for toolless bolting to 1/4" and 1/2" test valves
- Includes quick-release couplings for connection to the pressure
- With back pressure manometer with quick release coupling to test the output side RVs
- In practical aluminium case



KEMPER Module Program

Made completely of gunmetal, hygienically flawless



Advantages at a glance

- Can be flexibly combined with modular construction with basic flange for all function modules
- Complete from DN 15 to DN 50
- Parts that have contact with fluid (drinking water) made of gunmetal and stainless steel

KEMPER pressure reducing valve Module DM



Figure 710

KEMPER filter Module F



Figure 712

▶ Matching length to replace common market models

▶ Any installation length through 360° rotatable cartridge, that means preset pressure can always be read

▶ Hygienically advantageous design with visibly integrated dirt trap

▶ Pressure range 1.5 - 6 bar can be easily set without additional tools

▶ Differential-controlled backwash and monthly maintenance indicator

▶ Fast, easy and user-friendly backwash technology

▶ Hygienically advantageous design using opaque filter cups to prevent germ growth

▶ KEMPER backwash automatic
Figure 712 99 001 available as accessory

KEMPER pressure reduction filter Combination module DMF



Figure 713

KEMPER protection group module S DN 20

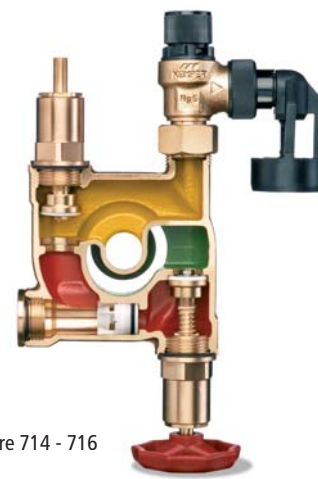

Figure 714 - 716

▶ Compact valve combination with only slight space requirements

▶ Effective system protection by combining the pressure reducing valve with a manually backwashable filter

▶ Differential-pressure controlled backflush and monthly maintenance display

▶ Fast, easy and userfriendly backwash technology

▶ Compact design in combination with all required parts with low space requirements

▶ Hygienically advantageous and streamlined flow design

▶ To protect from excess pressure on closed DWI's up to 1,000 litre contents

▶ With cut-off valve, controllable RV and additional 2nd stop, Membrane safety valve and drain funnel
In accordance with EN 1717

1
2
3
4
5
6
7
8
9
10
11
12
13

Save water, limit pressure, protect the system

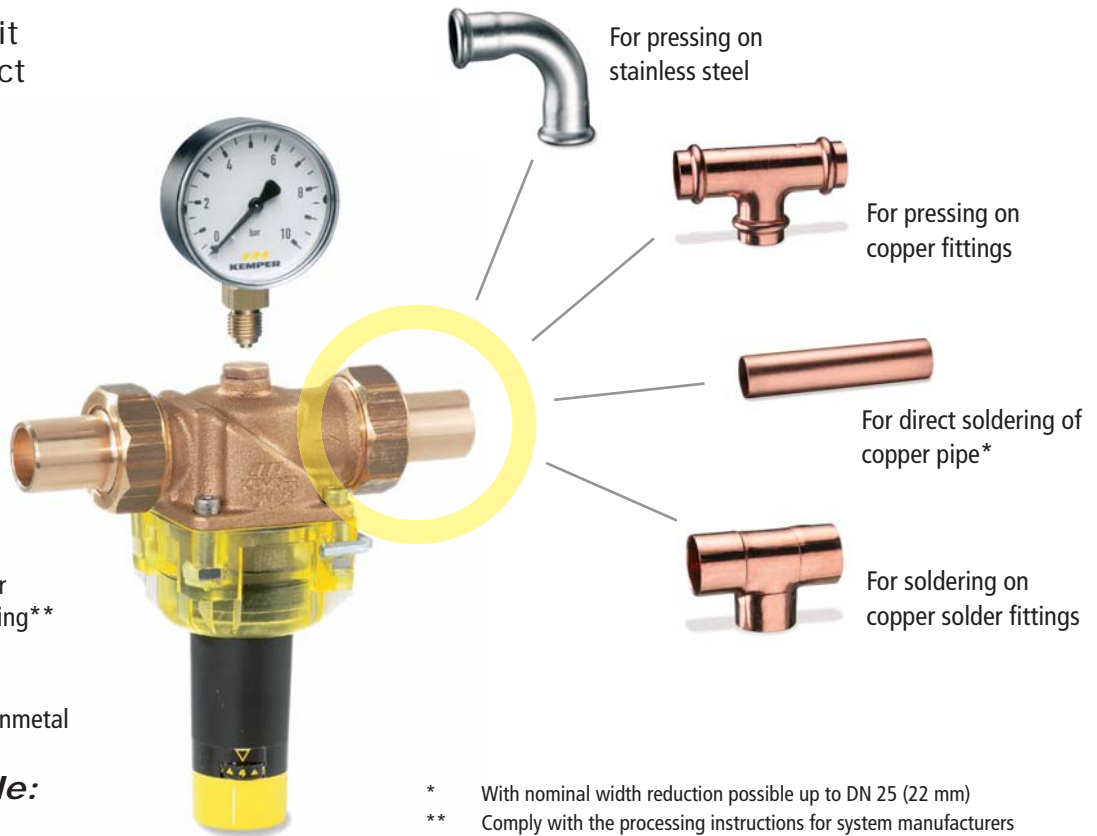

- **Fast:**
Universal fittings for soldering and pressing**
- **Safe:**
Made entirely of gunmetal
- **And suitable:**
For your calculation

* With nominal width reduction possible up to DN 25 (22 mm)
 ** Comply with the processing instructions for system manufacturers

Versatile coupling technology



Figure 710 0G



Figure 710 08

KEMPER pressure reducing valve module DM: Advantages at a glance

- Parts that have contact with fluid (drinking water) made of gunmetal and stainless steel
- Fitting length to replace common market models
- Fast, easy maintenance without needing to change the back pressure
- Any desired installation position with 360° rotatable cartridge
- Simple back pressure monitoring using the indicator scale or a manometer
- Visible strainer integrated
- Pressure range 1.5 - 6 bar can be preset without any tool
- DVGW and WRAS certified according to EN 1567
- Expandable with modules for house water filter, pressure reducing valve/filter combination and protection group

➤ The only size with DVGW permit



KEMPER Flange pressure reducer Figure 711

- Parts that have contact with fluid (drinking water) made of gunmetal and stainless steel
- Compact design by using compact, installation height
- DVGW approved according to EN 1567
- Pressure range from 1-7 bar can be preset, pressure levels PN 16 / PN 25
- Simple maintenance when installed
- Smoothly operating, simple pressure setting can be performed during running operation
- Control facility for the precompression and back pressure using a manometer included in the delivery
- Flow optimised



KEMPER Flange Filter Figure 708

- ### KEMPER Flange Filter
- Also during filtered water backflush supply
 - Completely replaceable filter
 - Fast and thorough filter cleaning combined with lower water consumption
 - Completely automatic filter cleaning with upgradable automatic backwashing
 - Backwash screen is covered during normal operation
 - Ball valve with lever and drain connection
 - KEMPER backwash automatic Figure 708 99 001 available as accessory



KEMPER hot water pressure reducing valve

➤ Use up to 90° C permanent temperature

- ### KEMPER hot water pressure
- Flow-optimised housing made of gunmetal, compact construction
 - DVGW approved according to EN 1567 incl. WRAS permit
 - Pressure range from 1-7 bar can be preset, pressure levels PN 16 / PN 25
 - Simple maintenance when installed
 - Smoothly operating, simple pressure setting can be performed during running operation
 - Control facility for the back pressure using a manometer included in the delivery



KEMPER Regulating valves

The threat from legionellas is growing. New TrinkwV water quality regulations obligate to take action.

When the new drinking water regulations (TrinkwV 2001) came into effect on 01-Jan-03, existing tolerance limits were tightened. Moreover, compliance with the limits is required at the building entrance, rather than the tapping point. An importance change as compared with the old German water regulations is the periodic checks made on the building installations for legionella in public buildings. The recommended values listed in the DVGW Worksheets will be maintained as the assessment basis. According to DVGW W 551, applicable is:

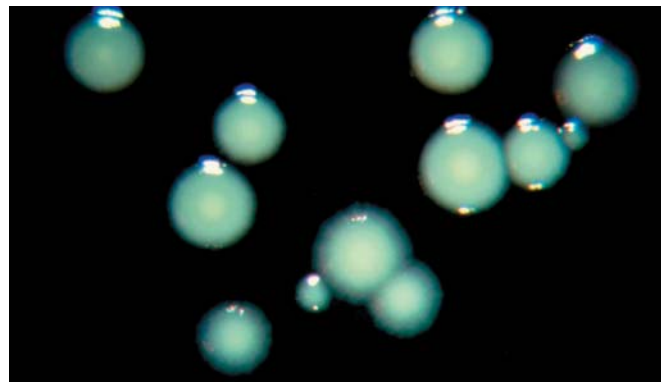

Growth of legionella from a contaminated water sample on a specific cultivation media (BCYE-α-agars)

Water quality regulation based on the example of Germany according to TrinkwV 2001

> 100 Legionellas (CFU/ml)	➤	Extremely high contamination	➤	Immediate disinfection and restriction of use, shower prohibition, repairs are indicated
> 10 Legionellas (CFU/ml)	➤	High contamination	➤	Repairs need to be made, hazard, possible restriction of use
0 Legionellas (CFU/ml)	➤	Target value	➤	No restrictions

If the target value 0 in 1 ml is not attained, take further actions on order of the health department according to § 20 (4). Health departments, as the official government validation organ are en-

titled according to TrinkwV § 9 to order a **shut-down of the water supply plant** without ifs or buts when the limits and requirements are not complied with.

Far reaching, painful consequences

Defective installations, stagnating water without tapping or with insufficiently designed drinking water circulation systems (DWC), especially in large, extensive, warm water systems, cause illnesses and deaths in Germany through legionellas.

For that reason, every person who plans and executes must be aware of his/her responsibility before implementing drinking water systems, e.g. in hospitals, nursing homes, hotels, schools, administration buildings and large scale residential objects.

Each individual must examine the hazard potential specifically for their building or object and develop a plant concept for implementation, operation and maintenance. When analysing germ-ridden plant systems, previously known types of potential hazards are repeated that alone or in interaction cause germination in drinking water systems. Especially the following potential hazards are to be prevented:



Hazard potentials

- ▶ Installation materials that emit nutrients usable by microorganisms
Setting up unnecessarily large warm water accumulator
- ▶ Warm water temperature level, in which the bacteria growth is promoted (at $T_{\text{WDW}} < 50^{\circ}\text{C}$)
- ▶ Hydraulic unbalanced warm water circulation systems and dead lines with stagnation manifestations



multiplication locations

Schematic of a warm water system with typical multiplication locations for legionellas

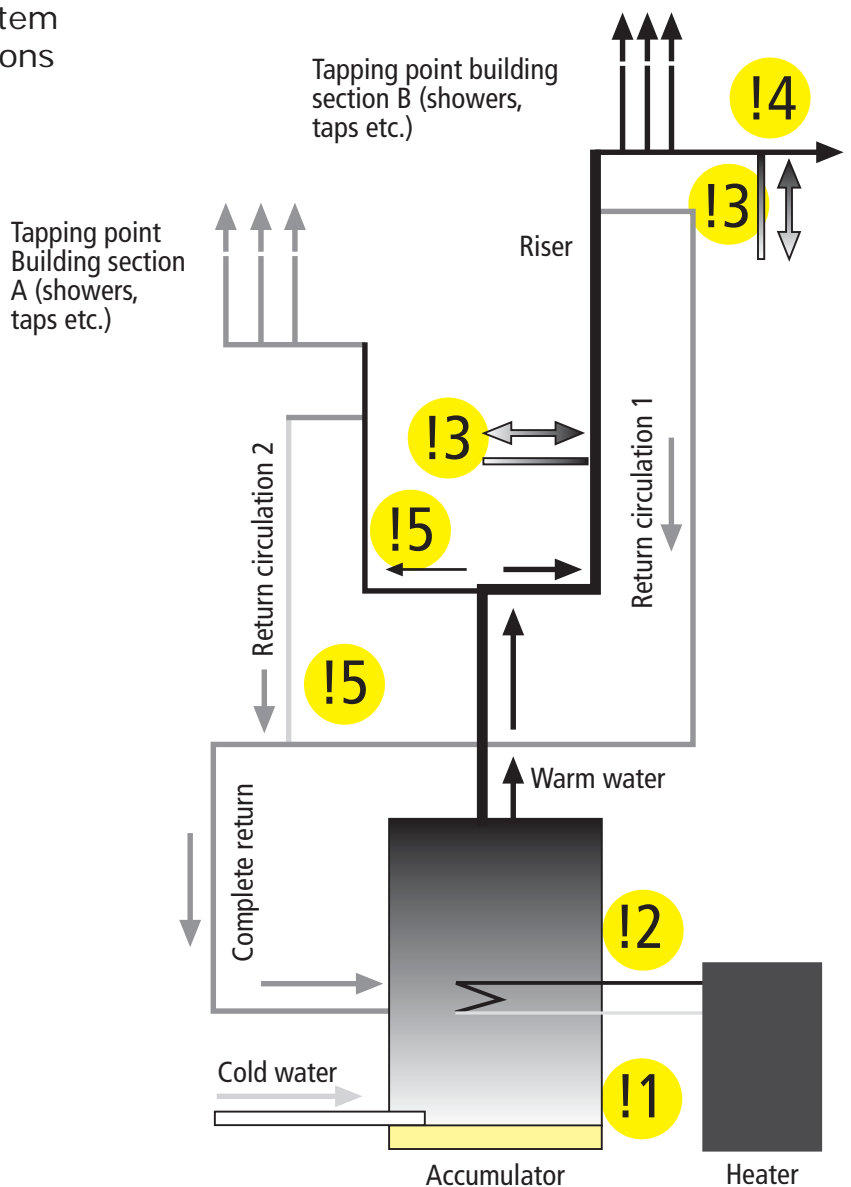

Multiplication sites for legionellas

- 1 Ferrous sediments
- 2 Thermal stratification in accumulator
- 3 Stagnating, non-constant flowed line section
- 4 Building 'in reserve'
- 5 Non-optimised circulation with the consequence of low-temperature zones

Maintaining drinking water hygiene in the warm drinking water system (WDW) based on the example of Germany

➤ Implementation of the DVGW worksheets W 551, W 553

➤ Consideration of the VDI Directive 6023

Dimensioning the drinking water heating (DWH), distribution and circulation plant during new constructions and repairs needs to take not merely the function and economic, but also the drinking water hygienic aspects into account.

For this reason, the DVGW developed suitable dimensioning methods for dimensioning circulation systems. These are published in Worksheet W 553 "Dimensioning circulation systems in

central drinking water heating systems" as a technical rule with the publishing date 12/98.

The Work sheet W 553 replaces DIN 1988-3 in section 14. Momentarily, the **following computational verifications** from the "Reference Works" for maintaining the drinking water quality in a professionally erected drinking water system **are considered mandatory**:

➤ Dimensioning the line system for cold and heated water according to DIN 1988-3

➤ dimensioning the circulation lines based on the DVGW worksheets W 551, W 553

➤ Verification of the water contents in non-circulating line sections

Laws, standards and directives

There are different standards, directives and laws in each country that protect the quality of drinking water and stipulate handling and transport in drinking water plants.



1

2

3

4

5

6

7

8

9

10

11

12

13



KEMPER 'Multi-Therm' circulation regulating

Legionellacontrol

Be happy: When designing your next circulation system, for the first time not everything revolves around the various valves, thermometers and connectors and the installation time needed for them. Instead, just use 'Multi-Therm' valves from KEMPER and forget the rest.

The hygienists demand sterile warm water! The solution: **KEMPER 'Multi-Therm' valves** for thermal disinfection. KEMPER supplies the proven and technically permanently improved range of regulating valves. Secure solutions for the drinking water distribution and circulation.

Proven, best value, robust mode of operation. Regulation valves from KEMPER provide permanent protection against hazard po-

tentials that could arise due to the materials used, the stagnation and low temperature levels in the warm water system.

'Multi-Therm': 4 + 1 in a compact system

- 1 Thermostatic regulating unit
- 2 Stop unit with mount for thermometer or sensor
- 3 Movable emptying unit and G 3/4 hose connection
- 4 Measuring unit with thermometer or temperature sensor
- + Automatic thermal disinfection

- Thermostatic-controlled regulation of the finest volume flows
- Stopping and temperature monitoring in one head-part
- Optimised emptying facility with a rotatable emptying valve
- Optionally available with electronic temperature sensor for building control systems
- High-quality in proven gunmetal quality, resistant to aggressive water
- Stagnant-zone-free
- DVGW, KIWA, ÖVGW, SVGW, WRAS certificate for plastic parts in contact with water
- For nominal widths from DN 15 - DN 25

Hygiene and comfort



kiwa



Finely temperature regulate, stop, empty and temperature monitor the volume flow. At the same time, the 'Multi-Therm' valve from KEMPER does not merely work in the operating temper-

ature range from 30 to 50°C and 50 to 65°C, but even automatically supports thermal disinfection at temperatures > 70°C.

Stopping, measuring



Stop valves with removable socket spanner, optionally available with insertable thermometer or temperature sensor for building control systems. Controlled via the temperature level, the valve can regulate, thermally disinfect and guarantee the required minimum volume flow.

Regulating



The operating set-point temperature can be set directly on the regulating head part. Control range: 30 - 50°C, 50 - 65°C KEMPER 'Multi-Therm' circulation regulating valves automatically set the hydraulic compensation of the circulation line amongst each other dependent on the temperature in the DWcT line and dynamically, temperature dependent at that!

'Multi-Therm' - regulation behaviour during operation

'Multi-Therm' - Control

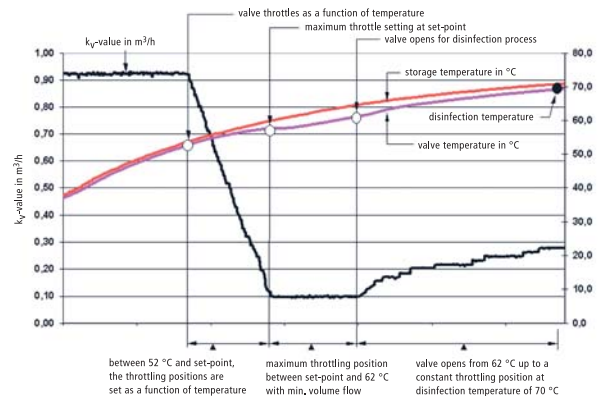
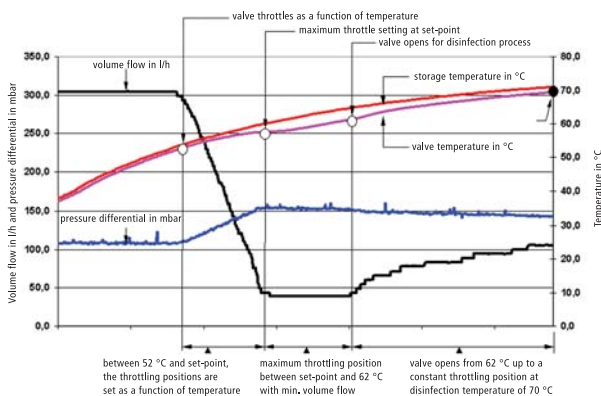

- 1
- 2
- 3
- 4
- 5
- 6
- 7
- 8
- 9
- 10
- 11
- 12
- 13



KEMPER 'Eta-Therm' floor regulating valve

Hydraulic compensation in the floor level

Now with DVGW permit according to VP 554

KEMPER 'Eta-Therm', the first automatic regulating valve for the hydraulic compensation of the floor level circulation.

Wherever due to increased requirements from hygienists or for comfort criteria

there is a necessity to tap hot water immediately after opening the valve. The floor level regulating valve can regulate smallest volume flows needed to hydraulically regulate temperature compliance in the sanitary block area. It implements hydraulic compensation at floor level. The KEMPER 'Eta-Therm' floor level regulating

valve is available in 2 versions. Installation is possible in the area of the individual sanitary block shut-offs as concealed regulating valves or as freely installed regulating valves.

Advantages at a glance

- Hydraulic alignment of circulation circuits in the floor area
- Automatic finest regulation valve with minimum flow-through values $k_{v\min} = 0.05$, $k_{v\max} = 0.4$
- Operating temperature range: 58 °C - 2K
- Medium-contacting parts made of gunmetal
- Multifunctional stop and regulation head-part 3
- 'Blind' valve presents for concealed installation made possible through rasterization
- Available with change stopper
- Integrated cleaning function

Free

Flush



With male thread Figure 130 0G



With female thread Figure 131 00



With female thread Figure 540 00



With press-fitting mapress Figure 542 02

Freely installed mounting

Concealed mounting

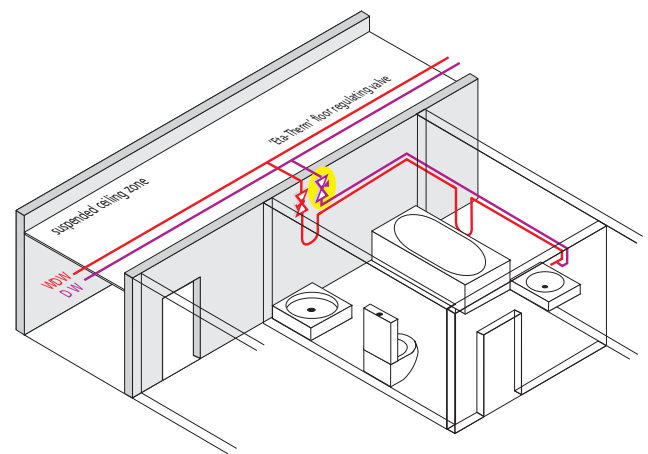
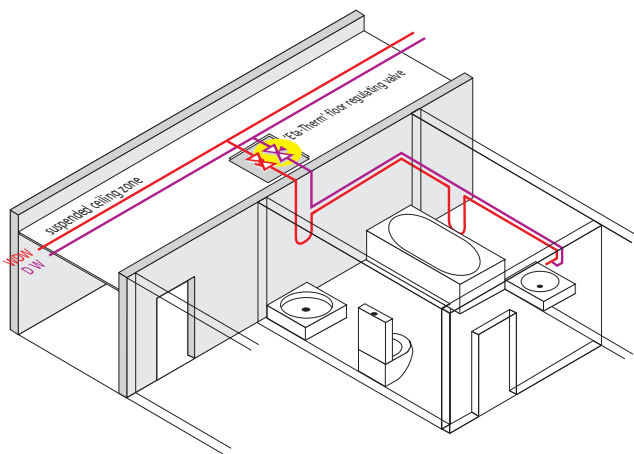

Branch plan -
Extract from a major project

KEMPER 'Eta-Therm' floor regulating valve. For compliance with hygiene and comfort demands as concealed valve for the hydraulic compensation of single sanitary blocks, e.g. in a hotel, hospital, nursing home.

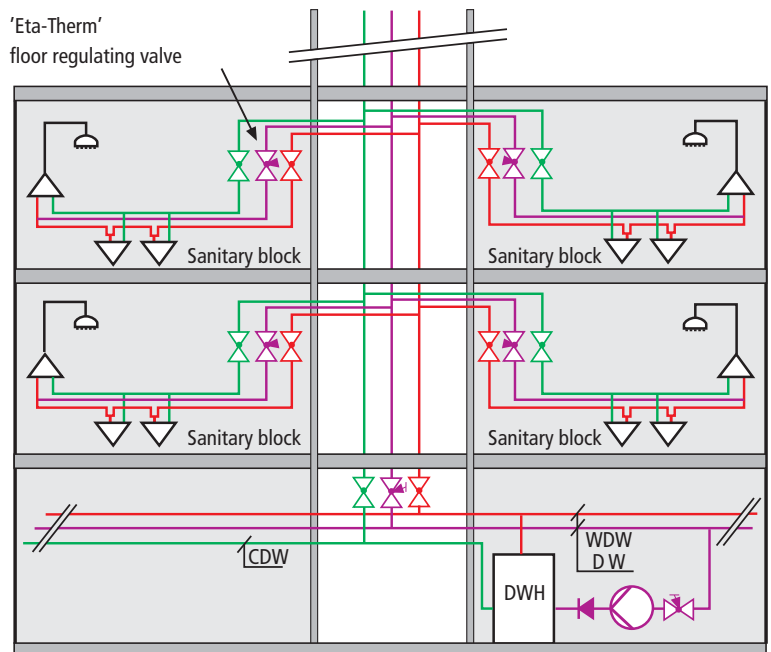

- 1
- 2
- 3
- 4
- 5
- 6
- 7
- 8
- 9
- 10
- 11
- 12
- 13



KEMPER 'Multi-Fix' circulation regulating valve

The manual, static alternative

Temperature and throttle setting display can be read at a glance!

For manual hydraulic compensation in the circulation system, the **'Multi-Fix' Circulation regulating valve** from KEMPER can be used to manually set the volume flows. The valve can be closed for maintenance work without needing to change the selected throttle default.

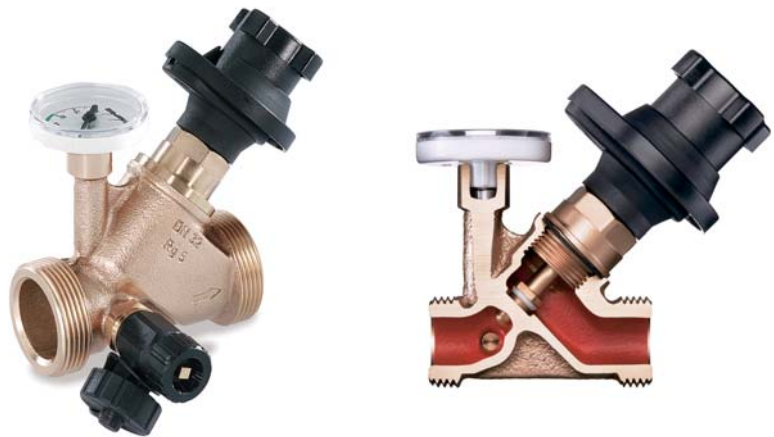

KEMPER 'Multi-Fix' manual/static circulations regulating valve Figure 150

Advantages at a glance

- With stop and drainage for maintenance work
- Including thermometer and optionally available with temperature sensor
- With self-lubricating EPDM lip seals that can be replaced under pressure as a maintenance-free spindle sealing
- Completely made of gunmetal, resistant to aggressive water
- Stagnant-zone-free
- DVGW and soundproofing certificate

Lower costs through professional sampling

Operating companies that provide water to the public are obligated to verify flawless quality. In order to do that, drinking water inspections need to be performed.

But in reality, there usually are not any suitable tapping points at these places, so sampling costs unnecessary extra time and cannot always be performed professionally.



Sampling - simple, safe, reliable

KEMPER sampling valves for determining chemical and microbiological parameters in drinking, bathing and swimming pool water.

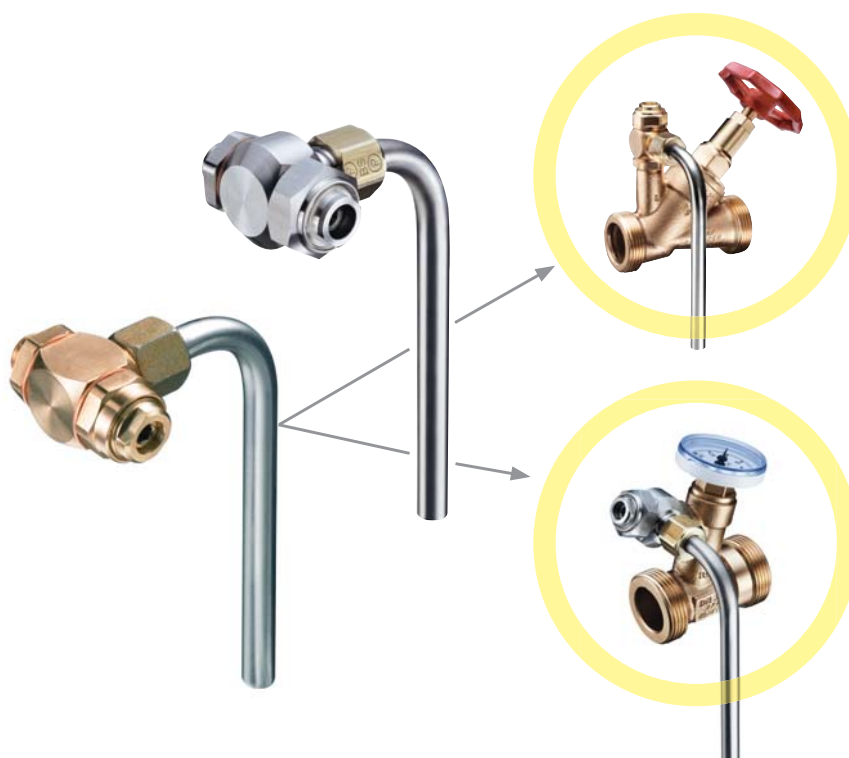

- One sampling valve for all kinds of sampling
- All parameters that need to be determined can be done at one single point
- Sampling equipment is easy to use and flame treatable
- Stable, long outlet elbow made of stainless steel generates a pencil-thick, straight and focused water jet
- With a hexagonal spanner, you can regulate the drain amount and stop the valve
- Valve housing and outlet elbow can be rotated 360°, so they can be aligned in any direction
- For building valves from DN 15 to DN 150 as G 1/4" and G 3/8" male thread designs
- Valve housing made of gunmetal or stainless steel
- Housing can be flamed as there are metal seals in the rotatable housing area
- High quality, hygienically safe PTFE seat seal

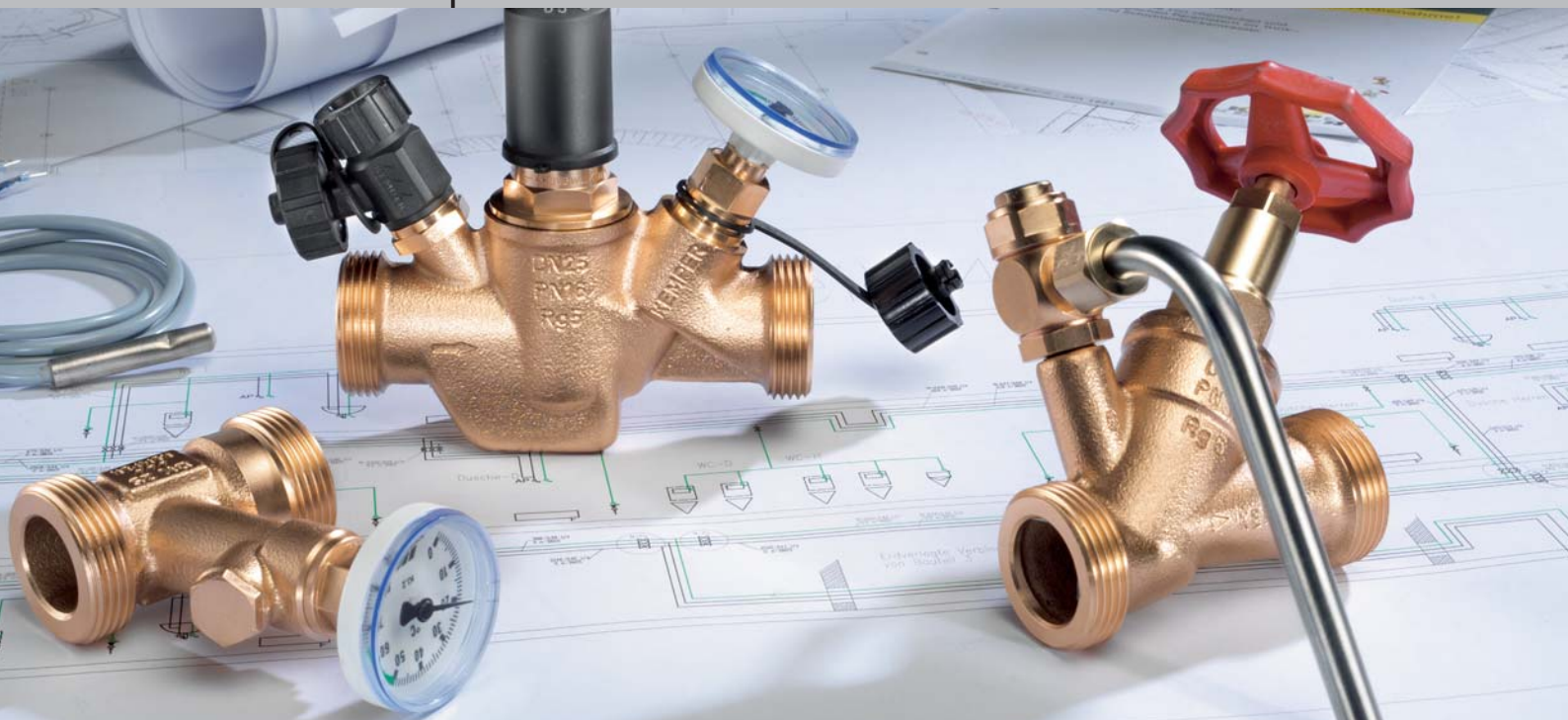

KEMPER 'Control' Vortex Flow Sensor with measurement

KEMPER 'Control'- to let you work quickly and precisely

Finally, the often time-consuming and cost-intensive adjustments needed in plants and pipeline systems have come to an end: The perfect solution is called the **KEMPER 'Control'**.

This new, low pressure-loss valve together with the mobile measurement computer gives you the right perspective and mercilessly uncovers existing disruptive factors. Volumetric flows can be precisely determined and adjusted and operating

conditions can be documented. That increases operational safety in new plants and the energy saving potential can be fully utilized, especially in redevelopment objects. Achieve effective, time-saving system adjusting by combining the measurement valve with KEMPER regulating valves Figure 150 or Figure 178.



Advantages at a glance

- Low pressure-loss sensor housing
- Exact volumetric flow determination
- High measurement precision at low flow velocities of 0.1 – 2.0 m/s
- Simple digital display of volume flow and temperature on the measurement computer
- Short, light design
- Volumetric flow valve made entirely of gunmetal
- With flat-sealing connection threads

1
2
3
4
5
6
7
8
9
10
11
12
13

KEMPER 'Multi-T-Piece'
Multifunctional and universally usable

To register and control the operating conditions in the entire drinking water installation, you can place the 'Multi-T-Piece' at any desired point. Suitable to mount measurement and regulation technology from KEMPER along with other manufacturers.



KEMPER 'Control': Vortex Flow Sensor
Figure 139 with measurement computer
Figure 138 and 'Multi-Fix'

KEMPER 'Multi-T-Piece'
Figure 128 with drainage facility



KEMPER 'Multi-T-Piece'
Figure 129 with thermometer



KEMPER 'Multi-T-Piece'
Figure 128 with Pt 100



- Can be used flexibly in the entire drinking water installation for temperature measurements, sampling, draining
- For connection to the building control system
- Outlet R 1/2" with integrated sensor pocket to mount the KEMPER indicator thermometer and Pt 100 temperature sensor
- Outlet R 1/4" to mount the KEMPER sampling or drainage valve
- Can be universally equipped with measurement and control technology from other manufacturers
- Flow optimized
- Low pressure-loss housing with full flow-through
- High-quality in proven gunmetal quality, resistant to aggressive water
- Stagnant-zone-free



KEMPER Hygiene System **KHS**[®]

Compliance with drinking water hygiene through periodic flushing

► **Periodic flushing must be secured in hospitals, doctor's offices and hotels, regardless of whether rooms are occupied or not.** ⁽¹⁾ ◀

According to the drinking water regulation (TrinkwV 2001), drinking water is always „Water for human consumption“. The requirements on the water tapping points must be complied with the drinking water system operator and affect both the warm and cold drinking water system.

The duty to comply with the generally accepted rules of technology result, for the operator of the building plumbing, from TrinkwV, § 4, ⁽¹⁾ in connection with § 3 No. 2 Letter c.

One thing is for sure: a preventative strategy, as opposed to a reactive strategy, is the only correct one.⁽¹⁾ Even before damage occurs, the recommendations for prevent-

ing and monitoring on ones own responsibility should be carried out. To do that, it is indispensable that the drinking water system in the cold and warm water areas be sampled in order to get a comprehensive picture of the quality of the drinking water at the tapping point.

⁽¹⁾ (German) Federal Department of Health Sheet, Health Research Health Protection 2006, 49:681-686DOI 10.1007/s00103-006-1284-X published online: 09.06.2006 © SPRINGER-Medizin Verlag 2006



This is how plumbing was installed up to now...

Both in the apartment construction sector as well as in public buildings (hotels, hospitals, doctor's offices, etc.), up to now flushing was only manual. Building in reserve with the consequential stagnation is still the order of the day.

Normal installation in a single-family house with all the known weak points. Stagnation across decades with the consequential hygiene and health risks.

A better installation but still with weak points. Depending on the line lengths while looping, large dimensions must be used. However, this is often not possible with conventional floor assemblies.

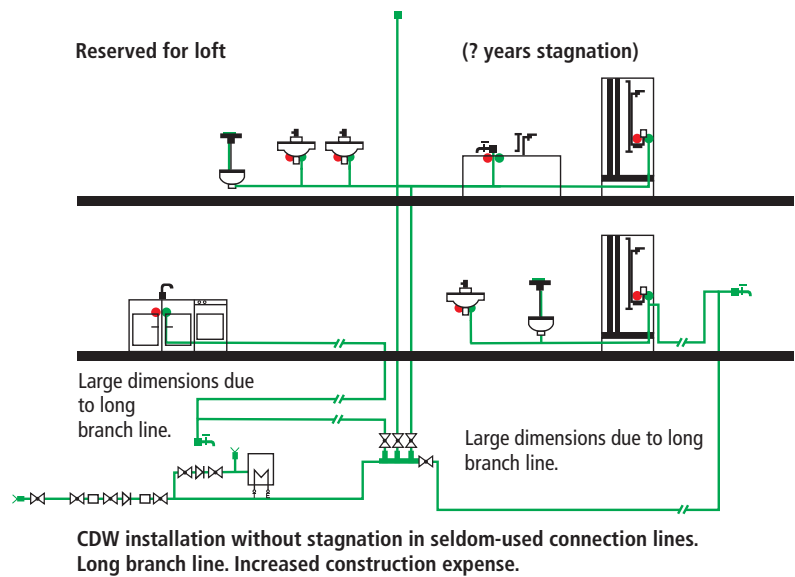
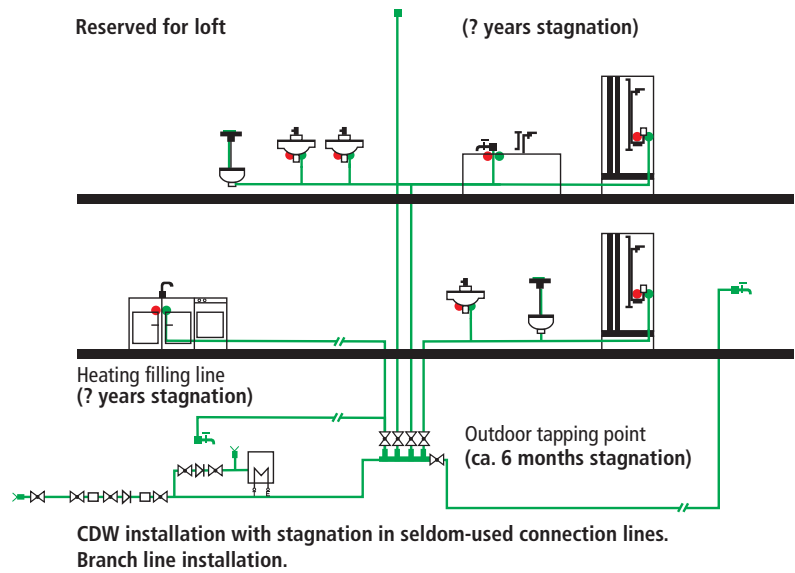

The solution

Hygienically safe installation with KEMPER KHS flow distributors and innovative piperuns.

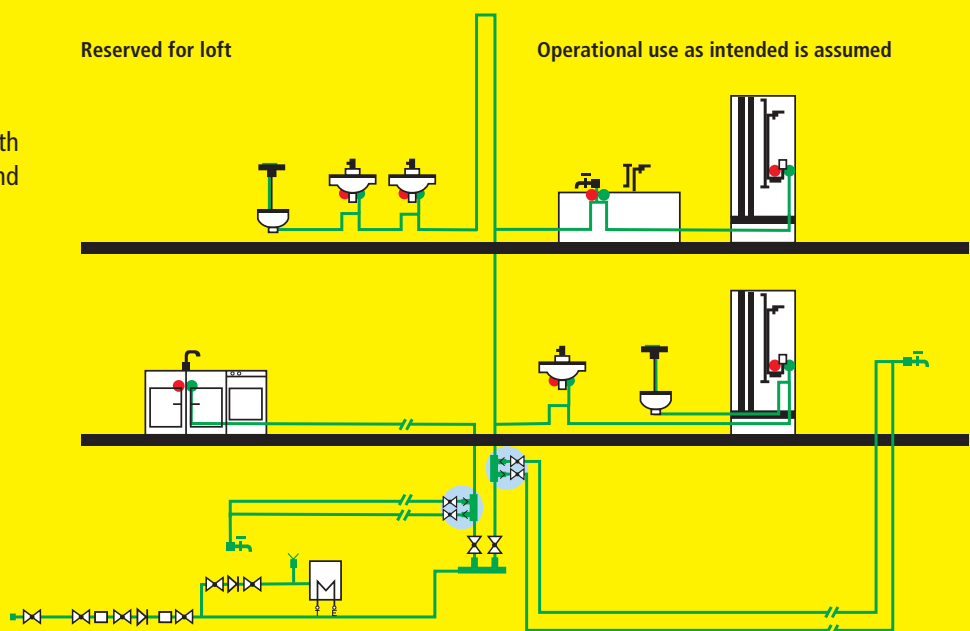



KHS-Multi-Circ Distributor Unit

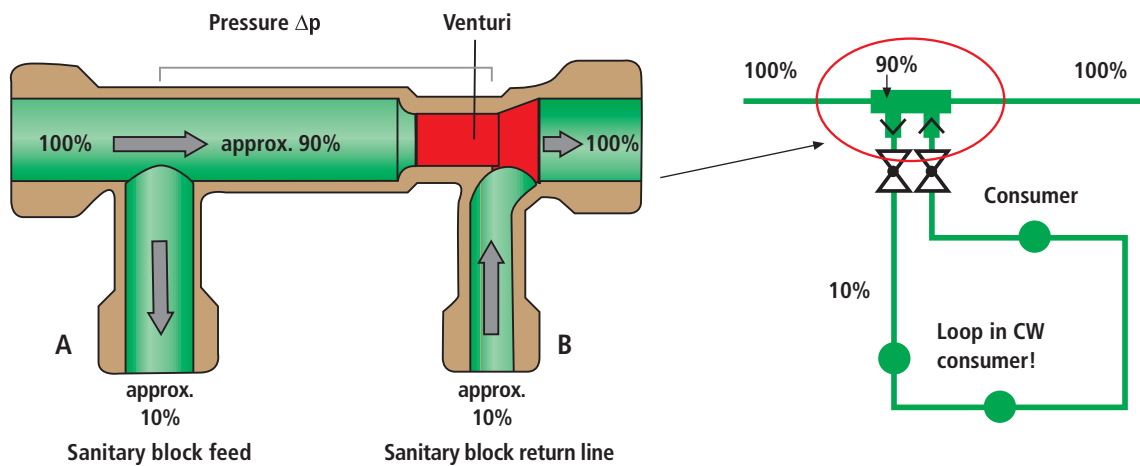

Automatic flushing

► The Venturi principle:

The reduced pressure in the nozzle causes a pressure difference. This pressure difference generates a flow in the ring line in the sanitary block. ◀

The innovation in the KEMPER KHS Hygiene System is the KHS-Multi-Circ Distributor Unit. The flow distributor's flow action is based on the principle of venturi nozzle engineering. The minimum pressure difference between Feed line A and Return line B causes a forced flow of the sanitary block. The drive comes from water removal after the KHS-Multi-Circ Distributor Unit. That replaces the entire water content in the ring line while keeping the drinking water temperature low.



Giovanni Battista Venturi

Simply ingenious - ingeniously simple. The principle discovered by Giovanni Battista Venturi still meets all requirements even today. In his productive period (*1746 in Bibbiano † 1822 in Reggio nell'Émia) he also developed the venturi pump and the venturi nozzle.

The ideal solution

Forced-flow circulation of sanitary blocks when not being used as intended - no consumption measurement in the floor level

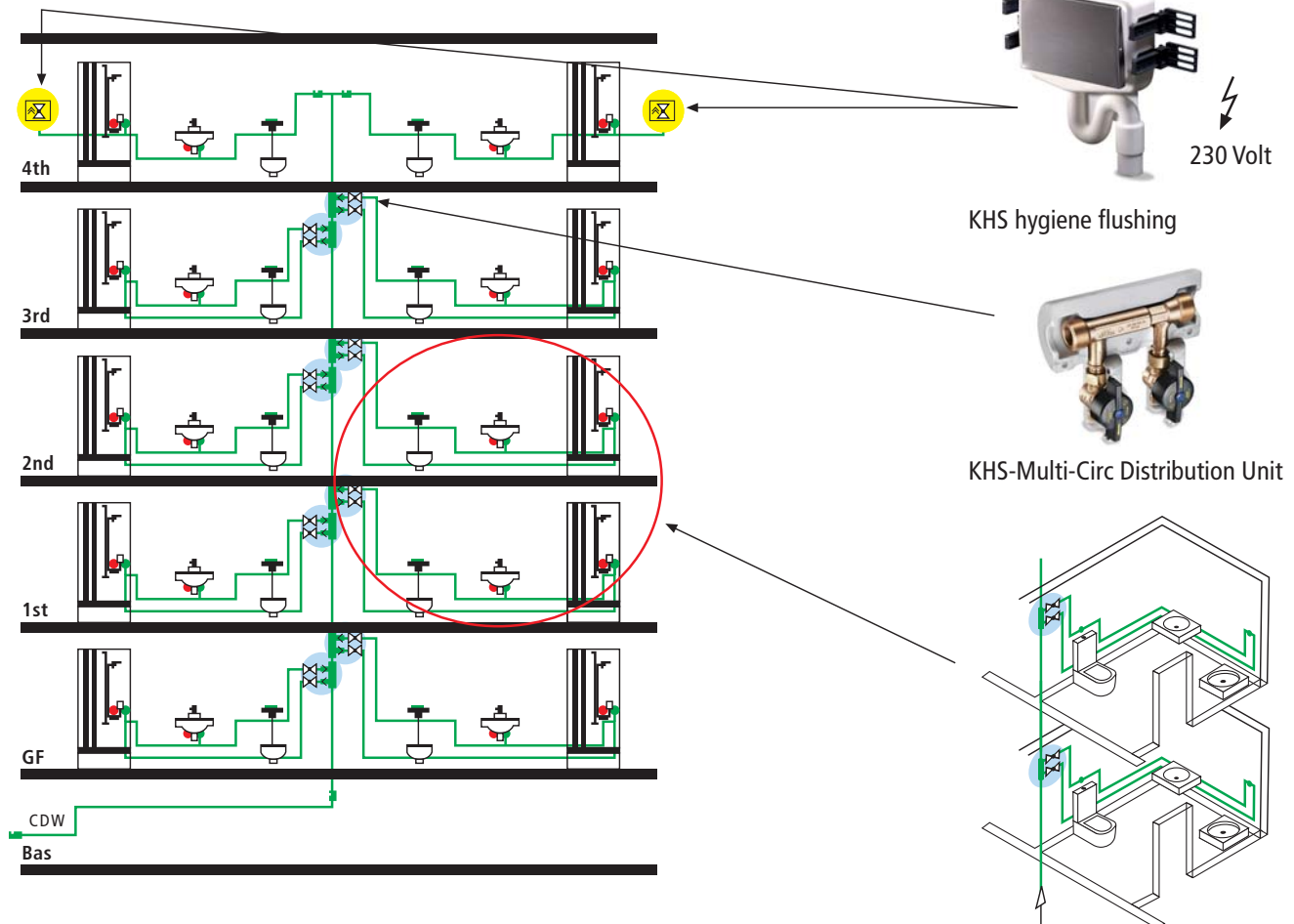

KEMPER KHS hygiene flushing and KHS-Venturi flow distributor group in the riser branch

Operational use as intended

The combination of KHS hygiene flushing at the end of the supply line and KHS-Multi-Circ Distributor Unit in the riser lines when the hygiene flushing process flows the floors underneath, maintaining use as intended.

The goal of the KEMPER hygiene system

- Securing and maintaining drinking water quality at the tapping point according to current specifications, laws and standards.
- Preventative measures to prevent stagnation in the drinking water system by creating use as intended operation at any point in time.
- Forced flow and continuous water exchange through dedicated pipeline system structuring using intelligent line routing.
- Reduction of staff and operating costs through controlled, economical flushing measures.

First Aid in existing buildings

Getting a hold on stagnation in existing plants is much more difficult than in new systems. The first and simultaneously most effective measure in existing systems is timercontrolled branch flushing. Schools,

sports venues and hotels can be quickly and effectively freed of stagnating water in terminal lines with this method. In fire extinguisher lines in the existing buildings, non-pressure surged flushing with DVGW

certified valves can be performed. With the various valve sizes, a 20- 50% volume flow of the calculated flow-through in the lines to be flushed can be secured up to DN 100.

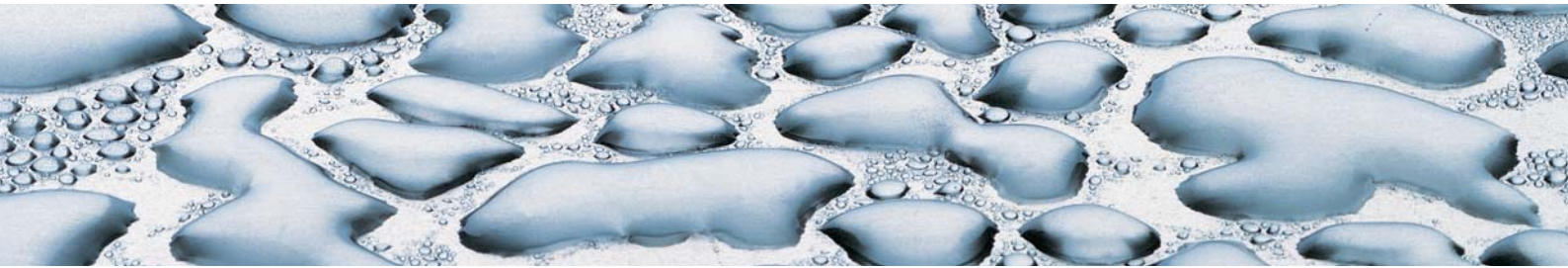

Drinking water hygiene by flushing terminal pipelines

► One thing is for sure: a preventative strategy as opposed to a reactive strategy is the only correct one. ◀

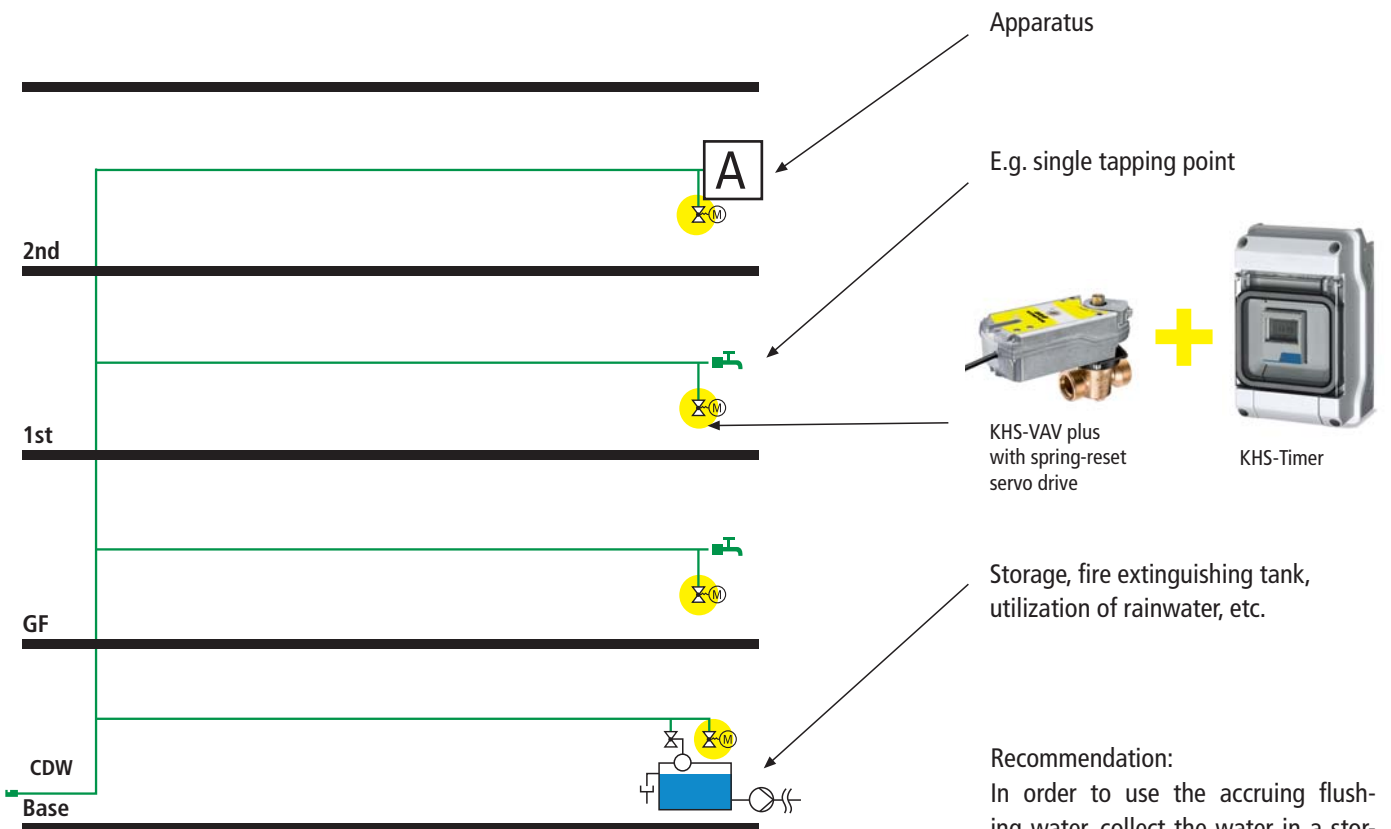

Recommendation:
In order to use the accruing flushing water, collect the water in a storage tank (e.g. rainwater harvesting systems, outdoor rainwater facilities, etc.).

Operating modes

Whether temperature, volume flow or time-controlled – the KEMPER KHS always provides the right approach. Large challenges need great solutions. In large systems, flushing with the hygiene flushing unit is not practical. This is where intelligent valve engineering is required.

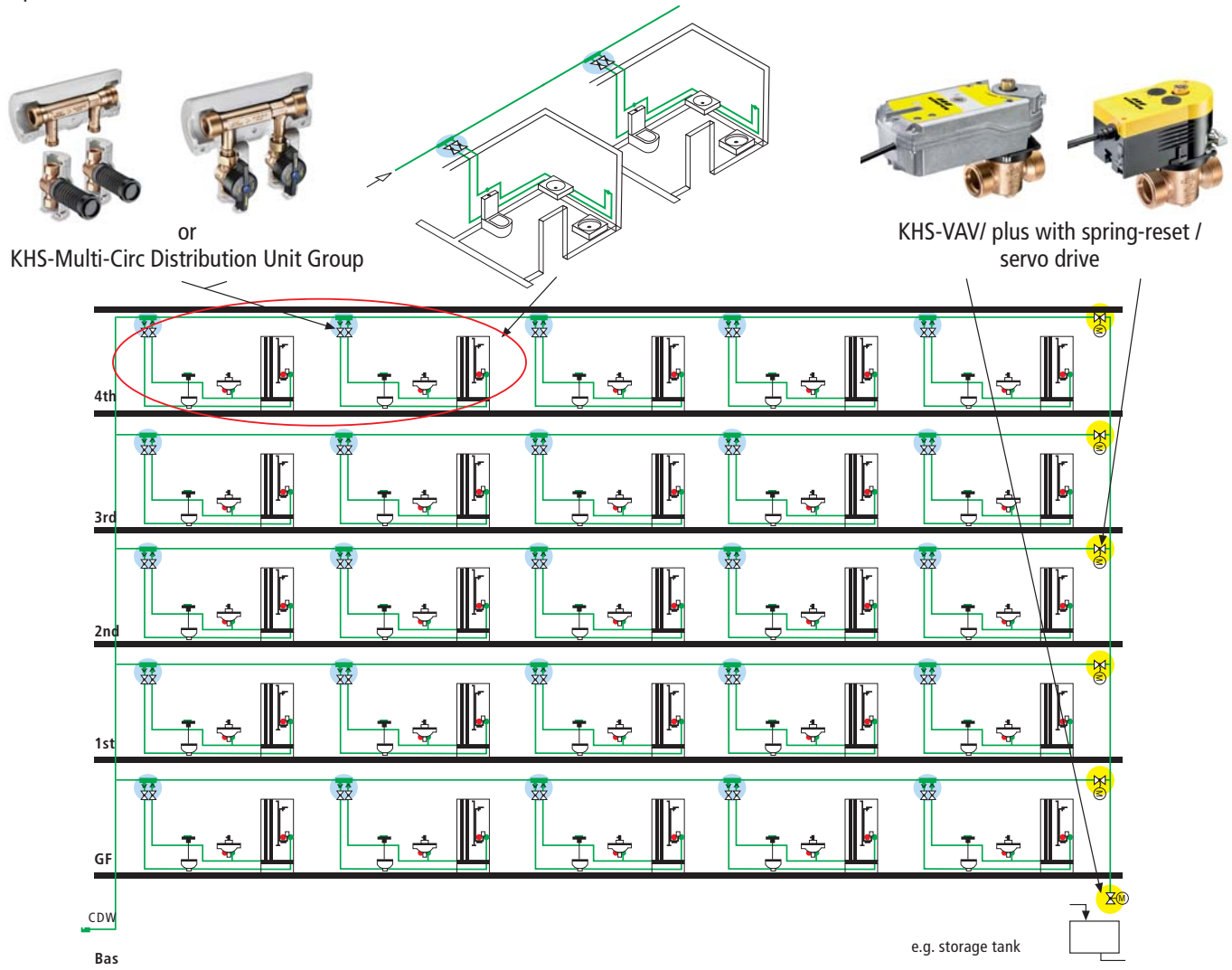

The operator can choose between three operating modes

- 1 **The time-controlled flushing process** for the drinking water system using the preset drain times (e.g. max. 5 flushing intervals across one day or individual flushing intervals on various weekdays during a week).
- 2 **The volume flow controlled flushing process** for the drinking water using present drain volumes during known, required flushing volumes.
- 3 **The temperature-controlled flushing process.** Here, a reference temperature (e.g. on the CDW building connection) is constantly compared with multiple temperatures in the piping system. The system control triggers flushing if the temperature difference exceeds the preset target temperature difference.

Valves, measurement and control engineering in KEMPER hygiene systems – the individual components

All individual components are DVGW certified



1. KHS-hygienic flushing unit with control valves and cover Figure 686 03



2. KHS-Multi-Circ Distributor Unit Group DN 15 - DN 32 Concealed mounting in wet cell area complete with KHS-Multi-Circ Distributor Unit, KHS-VAV Maximum flow isolating valves and insulating shell Figure 640 00/01/03/04



3. KHS-Multi-Circ Distributor Unit Group DN 15 - DN 32 surface mounting in shaft/ corridor area, complete with KHS KHS-Multi-Circ Distributor Unit, KHS-VAV Maximum flow isolating -valves and insulating shells Figure 640 02/05



4. KHS-VAV Maximum flow isolating ball valve with servodrive Figure 686 00



5. KHS-VAV plus Maximum flow isolating ball valve with spring reset servodrive Figure 686 01, Orifice panel Figure 687



6. KHS temperature sensor valve Pt 1000 with AG for fitting connection Figure 629 0G



7. KHS-vortex flow sensor with male thread Figure 638 00



8. KHS drain with overflow monitoring DN 20 - DN 32 Figure 688 00



9. KHS-Logic control system consisting of: Configuration software, control modules for sensors, valves, monitoring units Figure 686 02



OR



10. KHS timer set with VAV with servodrive or with VAV with spring reset servodrive

consisting of digital timer (incl. splashproof automat housing (IP65)) and maximum flow isolating ball with 230 V servodrive



KEMPER Leak Security System

Small cause - large effect!

Undetected leaks are the reason for costly reconstruction work in buildings after water damage. If there is a leak due to a burst pipe, weak points in the connection or in the drinking water system plant engineering, water often flows undetected for hours or even days in highly sensitive building sections.

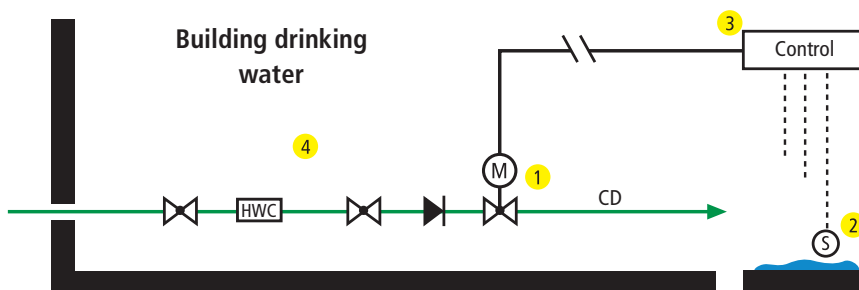

- 1 KHS-VAV-plus or KHS-VAV with/without spring-reset servodrive
- 2 Water sensor with up to 3 possible monitored lines
- 3 KEMPER Leak Controller with integrated timer
- 4 Location: Drinking water building connection room or roof units with DW heating

Advantages at a glance

- Secure registration of a leak by using a water sensor with immediate drinking water system shutoff
- Space-saving, easily retrofit package for all types of buildings in inventory as well as new buildings
- Maximum flow isolating ball without concussion through slow closing / opening according to EN 13828
- Timer programming facilitates automatic security when leaving the building or during long absences
- Acoustic and visual alarm to the leak controller reports a leak
- The alarm can be forwarded to a building control system (BMS)

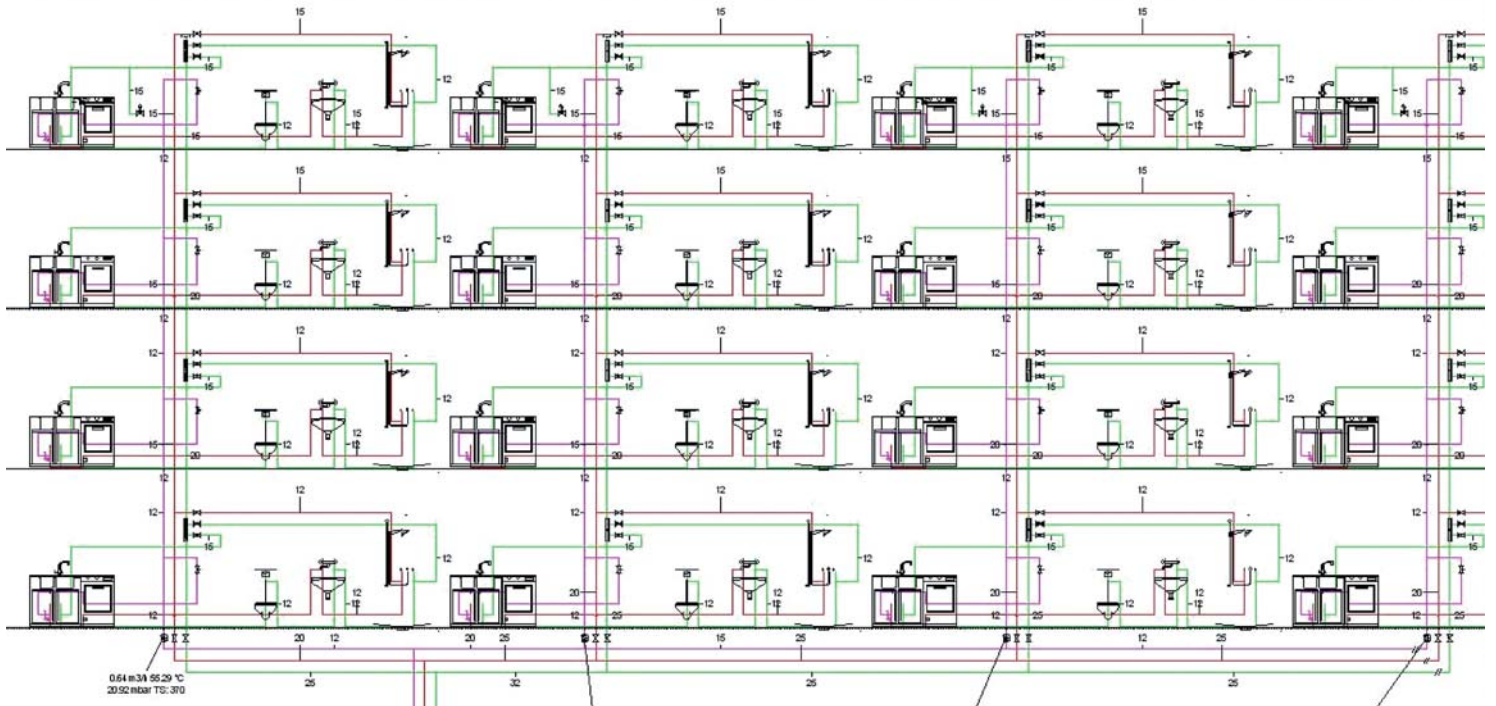

KEMPER Dendrit CAD - Calculation software

Planning security now also in CAD

Planning building engineering plants with the greatest planning security is guaranteed by the innovative KEMPER Dendrit CAD software.

Naturally, it includes consistent and uniform menu guidance. The drawing can be downloaded in CAD as DXF or DWG formats. Processing the downloaded floor plan and the entire hydraulic calculation in CAD is problem-free with the familiar Dendrit desktop.

Branch plans are now also automated CAD by the plan generator. That makes the drawing surface with CAD unlimited. Starting now, the hydraulics limits in Dendrit can be taken advantage of, as now the hydraulic calculation from up to 99 floors and 99 risers is feasible. The plan generator will save you 80% of the drawing work, even with different floors or with the most varied room usages – and that in the drinking water, wastewater, heating or gas pipeline calculations.

KEMPER Dendrit CAD provides the unique tool for circulation simulation as an add-on for standard-compliant calculation. Here, not only the temperature curve for the entire flow path is checked and optimised, but even the exact selection and settings for the valves and pumps are made.

The KEMPER KHS Hygiene System for preventing stagnation and temperature excursion in the cold-water sector is likewise implemented as a simulation tool. The KEMPER Dendrit CAD software is being technically accompanied by the Münster University of Applied Sciences and Prof. Bernd Rickmann. You can procure the complete software package or in modules for the drinking water, wastewater and heating or gas calculation sectors.



Fachhochschule
Münster University of
Applied Sciences



WILLO

SANHA

KEMPER

Dendrit

GEBERIT

GRUNDFOS

Planning security through calculation and simulation

KEMPER simulation tool for optimising

- Circulation simulations including the pump selection from the program by the company Grundfos und Wilo
- KHS simulation for optimising and determining flush times.

Drawing support

- Plan generator
- incl. CAD OEM Version

Operating

- Windows 2000 / Windows XP / **Windows Vista**

Piping network calculations

- Drinking water calculation including circulation calculation, Circulation simulation for optimising the temperature curve, valves and pump selection
- Wastewater calculation EN 12056
- Heating pipe network calculation
- Gas pipe network calculation

Building engineering

- Heating load calculation according to EN 12831
- Radiator design and floor heating calculation
- Cooling load Calculation

Advantages at a glance

- Unlimited drawing area
- New: Download floor plan and process in the familiar Dendrit desktop
- Achieve the greatest planning and operational security with the innovative simulation program for the KEMPER circulation and the KHS Hygiene System.

New: Not merely branch plans - now also floor plan processing.

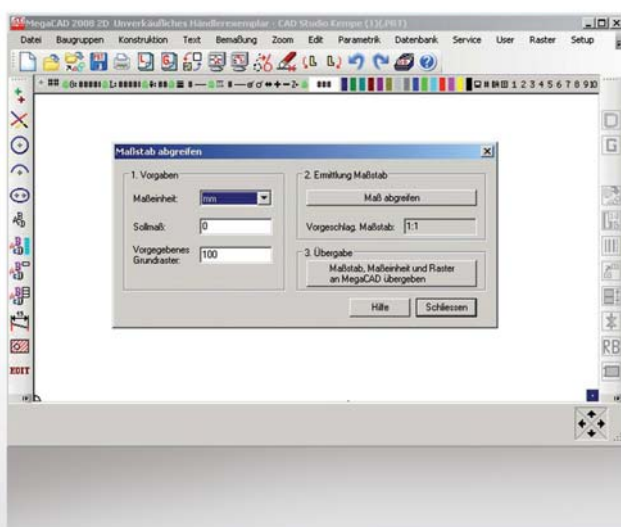

Defaults for hydraulic calculations in the customary Dendrit desktop

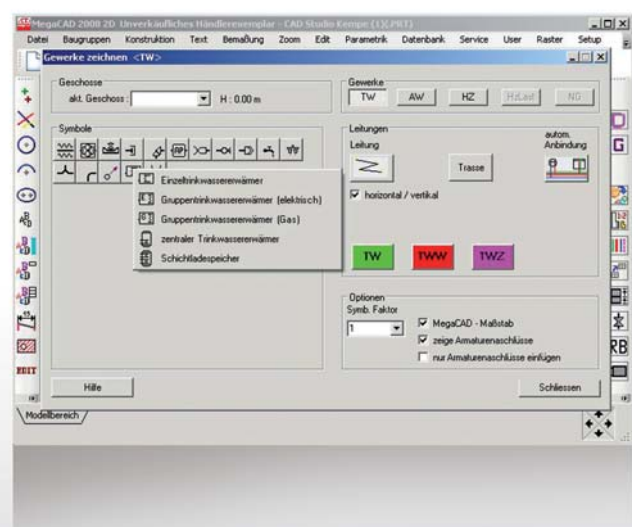



KEMPER 'UP-plus' concealed valves

Flexible with mature technology

The widely assorted KEMPER 'UPplus' range gives planners and plumbers a free hand for selecting materials and design, function and installation, coupling and connection technology. This versatility does not only offer a complete package of important benefits, but also pays off by saving costs in any installation: Flexibility for any wall and every trend. With pioneering technology.



KEMPER 'UP-plus' with integrated press-fit connection 'mappress' Figure 560 22



KEMPER 'UP-plus' with permanently integrated press-fit connections 'sanpress' and 'profipress' Figure 524

- With stop, regulation and presetting function
- Valve shaft and spindle extension made of high-quality plastic
- Variable installation depth up to 180 mm
- With pre-tiling protection and optionally with a set of fasteners for pre-wall installation
- Completely made of gunmetal, resistant to aggressive water
- With maintenance-free spindle sealing
- Stagnant-zone-free
- DVGW-/ SVGW and soundproofing certificate

Flexible in their function

KEMPER 'UP-plus' valves for:

- Stopping, regulating, presetting (basic equipment)
- Protection (optionally equipped with integrated backflow preventer)
- Also as automatic floor level regulating valve

in the entire floor installation for cold, warm and circulation lines as well as for individual sanitary elements.

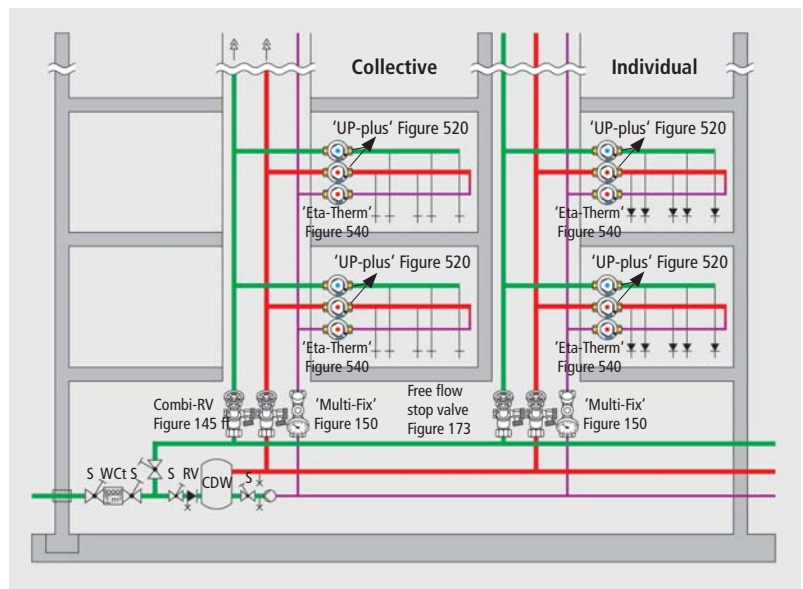

Installation principle with floor circulation with concealed valves for WDW, DWcT, CDW

Flexible in Design

'UP-plus' is available with the original KEMPER handle or with a closed detachable key element that protects against unauthorised access.

With the KEMPER adapter you also have the choice among the entire design variety for operating handles from brand name manufacturers.

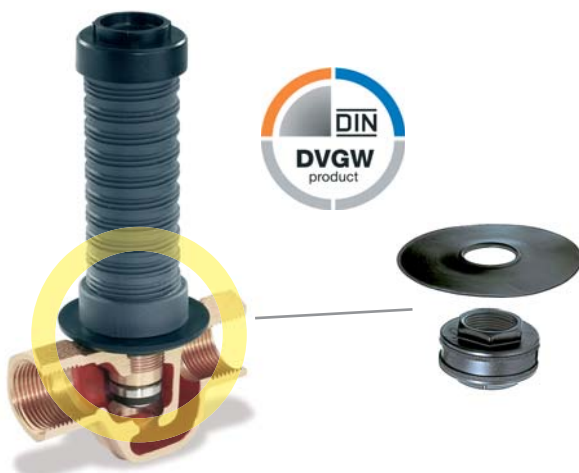
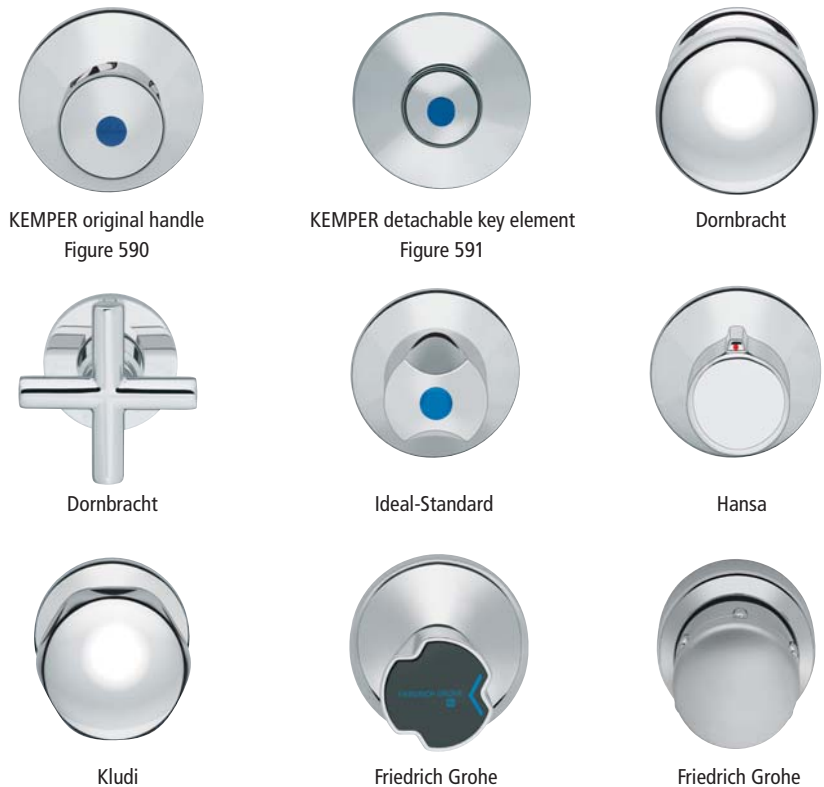

Flexible in the system technology

Sophisticated design details on the valve head-part and on the valve housing facilitate the versatile use of KEMPER 'UPplus' technology. Regardless of what piping system you decide on – with KEMPER 'UPplus' you have the matching coupling and connection technology available. Practical. Economical. Safe.

Flexible in assembly

Regardless of which installation depth 'UP- plus' is to be used: With the facility for cutting off just in front of the tiles and the shaft extension set, 'UP-plus' can be adapted to any desired installation depth.

Extension

KEMPER 'UP-plus' can be adapted to any requirements: You can lengthen the valve head-part depending on the desired depth in the masonry, register or shaft.



Extension set for 'UP-plus'
Figure 599

Flexible in coupling and connection

Anyone looking to get connected will find the most suitable solution at KEMPER in the flush segment. After all, with the large 'UP-plus' range, the right connection is available for all piping systems. That saves expensive piecework.

KEMPER has copper, stainless steel, plastic, composite and steel pipes for just the right connection.



KEMPER 'UP-plus' with female thread
Figure 560 01



KEMPER 'UP-plus' with 'Click' connection for various piping systems
Figure 560 08



KEMPER 'UP-plus' with permanently integrated press-fit connections 'sanpress' and 'profipress'
Figure 524



KEMPER 'UP-plus' with permanently cast Geberit 'Mepla' connection
Figures 560 09 + 591 00

KEMPER 'Click'

Furthermore, you can use 'UPplus' with the fast and secure KEMPER 'Click' connection everywhere and combine with all common piping systems.



Piping systems with KEMPER 'Click'

- Geberit 'Mepla' system
- 'mapress' system
- Unicor 'Unipipe' system
- 'sanpress' and 'profipress' system
- 'sanfix' system

Flexible in use

Whether floor level stopping or to cut-off individual sanitary elements, for installations in the shaft area, in the frost-resistant masonry or in register-type construction: KEMPER 'UPplus' provides specially developed constructions with which you can work securely and economically.



Register-type

You can install 'UP-plus' in all positions diffusion-sealed and noise decoupled in the register system. The set of fasteners optionally available and includes lock nuts, insulating shims and sealing sleeve.



Final

After adapting wall flush, the 'UP-plus' is completely assembled in a jiffy: Simply plug in the clamp unit with the push-on rosette, tighten with an openend wrench or hex key, slip-on the operating handle, finished!

➤ Our tip

The pre-tiling protective cap facilitates activating the valve already in the pipe installation phase (e.g. for seal tightness test).

The ingenious coupling and connection technology lets you easily combine KEMPER 'UP-plus' with all conventional apartment water meters – just solder, pressfit or bolt on. Individual bore hole gauges are available on request.



Masonry

'UP-plus' is fastened to the feed and outlet pipeline and sealed with the sealing sleeve. That means you can install 'UP-plus' in all positions diffusion-resistant and noise decoupled in the masonry.



Wall flush installation

You can cut to size with an angle grinder and stone disk, with our optional roller cross-saw or with a hand saw.

1

2

3

4

5

6

7

8

9

10

11

12

13



KEMPER Stop Water Meter Assortment

No such things doesn't fit.

The solution: The KEMPER stop water meter range with defined hole gauges between the stop unit and the water meter.

Align, bolt on, connect. Fast, exact, clean. Mounting concealed valves and water meter housing with KEMPER combination,

pre-mounted water meter units and meter boxes can be that easy and time-saving. Especially in difficult to access spots. You can finish the complete installation in a few minutes and end up with great results. And that's just fine with your customer. At the same time, the famous KEMPER

quality guarantees additional protection – because the stop valve and water counter housings are made entirely of gunmetal.

Advantages at a glance

- Fitting solutions for any installation situation: Masonry, register and drywall installations
- For time-saving, secure and clean assembly
- Perfectly aligned assembly through permanent connection of water meter and stop units
- With permanently defined hole gauges, also according to the tile raster (153 mm), other dimensions on request
- Installation depth variable
- With streamlined, stagnant-zone-free concealed valve 'UP-plus', with maintenance-free spindle sealing
- Optionally with multi-water meter housing G2"-coaxial based on model HWW or with manufacturer-specific water meter housing for installation in apartment water meters
- Completely made of gunmetal, resistant to aggressive water
- Can be combined with conventional piping systems using KEMPER 'Click' and female thread



KEMPER stop valve water meter combination Figure 855

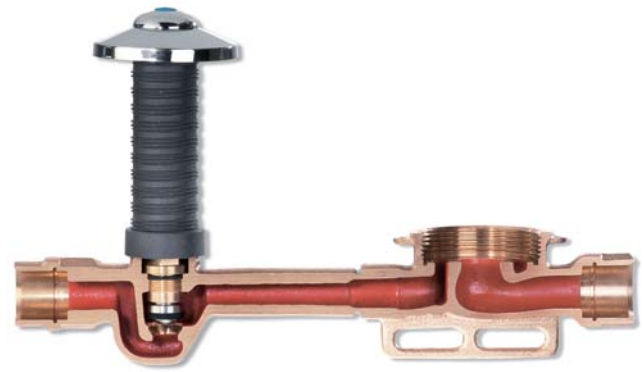

Figure 855

Manufacturer / make linkage – disadvantages that constrict

Many of the different water meter systems, meter housings and measurement capsules cannot be combined with each other. Up to now, that has been the problematical reality. The expert planners and executing companies have the problem already during the planning and raw installation phase that the later measuring system or measuring service has generally not yet been found or determined. With the necessity of stipulating one water meter make in this phase, system changes were impossible or only at great cost.

The developer or operator also often saw themselves in a difficult situation if they wanted to exchange it for a more suitable water meter make later on.



The great freedom with KEMPER G2"-coaxial water meter housing Model HWW

The model name HWW is a result of the fundamental specification by the Hamburg Water Utilities for installing G2"-coaxial water meter housings.

KEMPER provides the solution with Model HWW: a universal multi-water meter housing G2"-coaxial. This housing facilitates using the G2"-coaxial measurement capsules from leading man-

ufacturers – and that without adapters! That means changing the measurement capsule make can be done any time without problems.

Building operators, expert planners and dealers now have the freedom when selecting the measurement service.

- Cost savings through freedom of measurement service selection
- Measurement service neutral, simplified tender calling
- Cancellation of the manufacturer/make link
- Measurement capsules can be easily replaced any time



KEMPER stop water-metercombination
The economical, space-saving route for any installation



Figure 855



- Fits even in narrow spaces, e.g. when renovating
- Flexible through versatile installation lengths and hole
- Gauges 153 mm according to tile raster, 130 mm, 90 mm (with activation cap for concealed inspection flap installation), other dimensions on request
- For single cold or warm measurements
- Universal for masonry, shaft, register and pre-wall
- Assembly with versatile fastening facilities for register and prewall through optional mounting foot
- With insulating shell as accessory, Building Material Class B1

KEMPER stop water-metercombination 'DUO-plus'
The inexpensive, compact dual route for cold and warm water metering



Figure 867

- Universal for masonry, shaft, register and prewall mounting
- Completely mounted with DUO-attachment foot for register, installation rails and wall mounting
- Hole gauge 153 mm according to tile raster
- With two integrated insulating shells, Building Material Class B1

KEMPER stop WCt box 'DUO'

The clean solution behind the wall for register and prewall mounting in dry walls



Figure 870 07

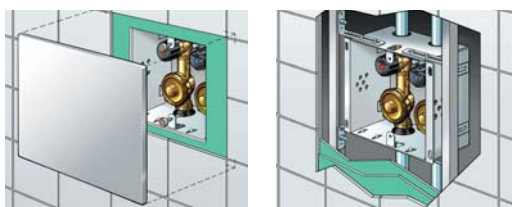

- Fits any prewall system with its versatile fastening facilities and comprehensive accessories
- Flexible in design through various KEMPER covers
- Can be combined with standard inspection and covering systems, Suitable for wireless layouts
- Space saving through small dimensions of the galvanized installation box (200 x 200 x 125 mm)
- With insulating shell as accessory, Building Material Class B1

KEMPER stop pre-mounted water meter units 'MONO' and 'DUO'

The rapid and safe blocks: Align, bolt on, connect - finished!



Pre-mounted unit 'MONO' Figure 856 for individual measurements in basement, shaft and floor level



Pre-mounted unit 'DUO' Figure 857 for floor level metering

- For time-saving, clean mounting, can be immediately tiled
- Pre-mounted mounting angle makes it universally usable for masonry, register and prewall mounting
- Optimal alignment through integrated alignment aid
- Simple to maintain tile raster dimensions through 153 mm hole gauge
- Optimal heat insulation through 2-component PU-foam, EnEV recommended values for heat losses are clearly undercut
- Optimal noise insulation, damp-proof, Building Material Class B2
- If desired, with F90 fire-prevention jacketing and test certificate



KEMPER 'Frosti®' – NEW

Drinking water quality secured year round

Original
with integrated hose
union anti-vacuum valve

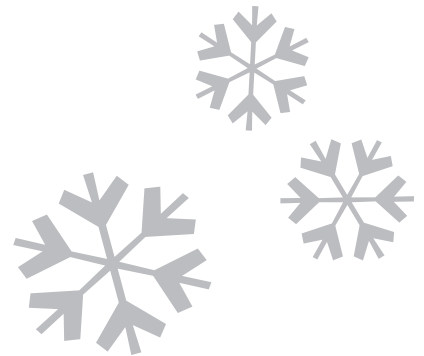

The NEW ice-cold benefits

- Safer protection from frost damage through automatic draining after each activation
- Hygienically safe: No stagnation volumes, no heated-up water
- Only one installation length for all conventional depths (for wall thicknesses up to 415 mm*)
- Continuous adaptation to outdoor wall thicknesses (from 150 - 655 mm)
- Above-average drainage capacity of 40 l per minute at 1 bar flow pressure
- Can be completely opened or closed with only 2 turns
- Drain pipe ventilator „loss protected“ (accidental removal not possible)
- Quick and simple assembly

* with surface mounting

KEMPER 'Frosti®-plus' The assembly kit
Figure 574

The assembly kit for finished installation facilitates mounting the valve already during the shell construction phase. The drain housing is mounted to the outside wall after the finishing work.

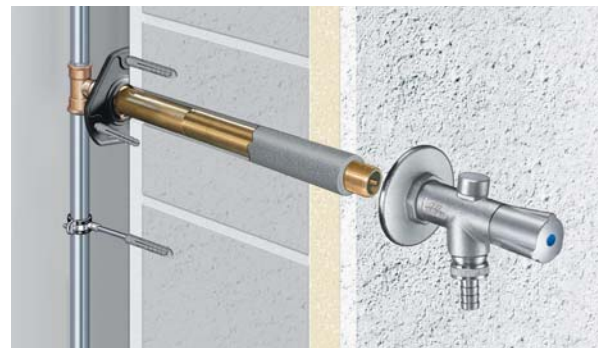

Anti-vacuum valve
integrated loss-free

New: Only one installation length
for wall thicknesses up to 415 mm*



KEMPER 'Frosti®' factorypremounted
Figure 577 02

The factory premounted valve for subsequent, fast, and simple mounting in previously finished outdoor walls. With a total exterior dimension of only 26.40 mm and shiftable rosette.

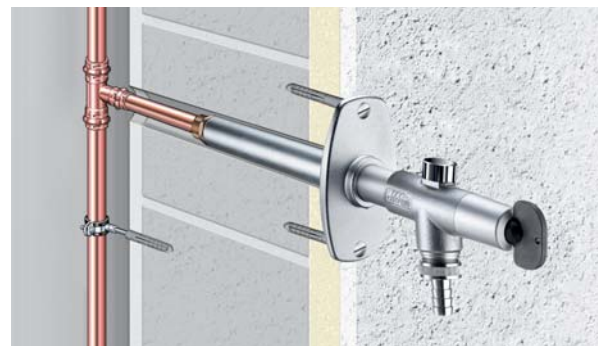

kiwa



Optionally with
lockable operating handle

- 1
- 2
- 3
- 4
- 5
- 6
- 7
- 8
- 9
- 10
- 11
- 12
- 13



KEMPER 'Tresor'



Lockable built-in wall cupboard made of highgrade, brushed stainless steel no. 1.4404

With socket combinations 230 V / 400 V, Make Mennekes, protection class IP 44, equipment can be chosen as needed

With KEMPER frost proof outdoor valve with automatic drain function, with DVGW and noise protection permit

- Comfortable water and electricity supply from a central point outdoors
- Noble in design because made entirely out of high quality stainless no. 1.4404
- Secure protection against unauthorised water and electricity tapping during use through integrated flap for hose and cable connection
- Secure plug lock can be converted to an existing lock system
- With KEMPER frost-proof outdoorvalve: Guarantees frost-proofness
- With socket combinations for 230 and 400 Volts, made by Mennekes, IP 44, hard wired, can be supplied for D, A , CH, DK, F, GB; optionally with fault current protection in box
- Safe cut-off of water and electric connections in accordance with VDE Directive for moist areas and rooms VDE 0100 Part 737
- Available as modular system: Size and equipment freely selectable as needed

KEMPER 'Mini-Tresor' Figure 211 / 212

Technically mature and noble in design: KEMPER 'Tresor', the compact supply station for the outdoor area, facilitates simultaneous, comfortable water and electricity supply at one central point. Regardless of which application and which device, you can always find the fittingsize and equipment.



KEMPER 'Mini-Tresor' built-in wall cabinet Figure 211, H/W/D: 340x300x120 mm, the compact supply station for a single-family house



KEMPER 'Mini-Tresor' surface mounted cabinet Figure 212, H/W/D: 315/280/132 mm

KEMPER 'Tresor' Figure 210 / 213

The supply station with various connection facilities, e.g. water and electrical connection for 230 V / 400 V, can be expanded at construction site e.g. with gas, telephone, antenna or wastewater connection, for private and commercial applications.



KEMPER 'Tresor' built-in wall cabinet Figure 210, H/W/D: 470x250x120 mm, for flush mounting



KEMPER 'Tresor' surface mounted wall cabinet Figure 213, H/W/D: 510x285x130 mm, for subsequent fast and clean installation in previously finished outdoor walls and when the wall thickness is insufficient for flush mounting

Safe and comfortable in use



- Safe for public buildings (schools, kindergarten, hotels, fire department buildings), events (markets, festivals) camping sites, residential construction
- Comfortable for various applications with electricity and water, for the garden, patio, penthouse apartment (lawnmower, electric grill)

Installation situation

The compact supply unit KEMPER 'Tresor' can be easily integrated in the masonry or concrete walls. To guarantee frost-proofness, a residual wall thickness of 180 mm is required.

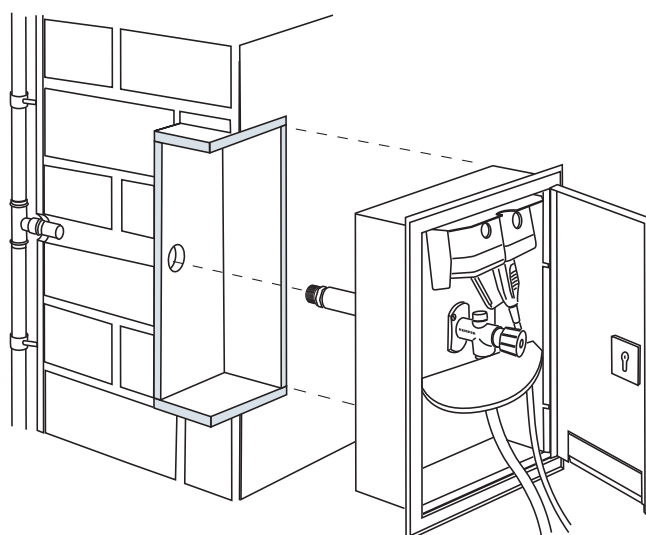

1
2
3
4
5
6
7
8
9
10
11
12
13



KEMPER System Valves

Advantages at a glance

- Material and time savings by using integrated press-fit connections
- Guaranteed hydro-tested tight connection
- Full warranty if installation guidelines are observed

System valves 'sanpress' and 'profipress'

The advantages for the finisher are clear: KEMPER valves with 'sanpress' and 'profipress' piping systems are installed quickly, safely and inexpensively.



stop valves with permanent press-fittings with SC-contour systems 'sanpress' and 'profipress' Figure 190 30



KEMPER 'UP-plus' concealed valves with permanent press-fittings with SC-contour systems 'sanpress' and 'profipress' Figure 524 00

System valves 'mapress' and 'Mepla'

KEMPER provides the fitting system valves for the Geberit piping systems Mepla, Mapress stainless steel and Mapress copper with permanently integrated press fittings made out of gunmetal and stainless steel.

Consistent implementation of the system concept is carried out with only two valve types for the three piping systems.

■ GEBERIT



KEMPER anti-pollution check-valve with permanent press fitting with contour sealing system 'mapress' stainless steel and 'mapress' copper Figure 193 22



KEMPER maximum flow isolating ball with permanent press fitting system Geberit 'Mepla' Figure 385 40



KEMPER 'Multi-Therm' with permanent gunmetal press fitting with contour sealing system 'mapress' stainless steel and 'mapress' copper Figure 143 22



KEMPER 'UP-plus' concealed valve with permanent press fitting, System Geberit 'Mepla' Figure 560 09

System valves 'Sanha'

KEMPER SANHA® system valve- with uniform system

Because, for the SANHA® connection technology with copper pipes and the SANHA® stainless steel piping system NiroSan® the matching system valve is now available from KEMPER.

SANHA®



KEMPER stop valves with permanent press fitting for copper piping system 'Sanha' and stainless steel piping system 'Niro-San' Figure 190 35



KEMPER 'Eta-Therm' with permanent press fitting for copper piping system 'Sanha' and stainless steel piping system 'Niro-San' Figure 546 02



KEMPER Stainless Steel Valves

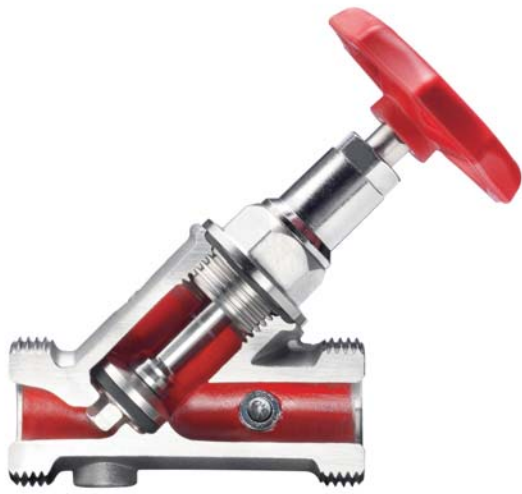

KEMPER free-flow stop valve Figure 073

Now the large range with new connection facilities: With universally male/female threads or Geberit mpress direct press fitting system

For premium demands in drinking water installations, KEMPER now offers a large selection of valves made entirely of stainless steel for stopping, securing and regulating for both surface and concealed mounting. In processed drinking water (such as fully demineralised water and softened water), stainless steel, with its excellent material properties, is also the safe alternative. Guaranteed perfect protection against corrosion with aggressive water.

➤ You can find more information about the extensive gunmetal valve range in chapters 2-8.

- Completely stainless steel, resistant against aggressive water
- With self-lubricating EPDM lip seals that can be replaced under pressure as a maintenance-free spindle sealing
- Stagnant-zone-free
- DVGW and soundproofing certificate
- Connection facility for all common pipe systems

KEMPER stop valves

With universal connection facilities for all common piping systems through the flat-sealing threaded connections and permanently integrated mapress press-fit connection.



KEMPER free-flow stop valve with flat-sealing male thread Figure 073 1 G



KEMPER free-flow stop valve with permanently integrated 'mapress' press fitting Figure 073 01



KEMPER Insulating universal shells for all KEMPER free-flow inclined valves Figure 471 10

KEMPER protection valves

KEMPER protection valves for protecting drinking water according to EN 1717. Reliable, safe and technically mature solutions, smooth operating and soft sealing. With stable protection function for long-lasting functional reliability.



KEMPER comb-check valve for protecting and stopping Figure 060

KEMPER antipollution checkvalves (RV and KRV)



KEMPER check valve RV for protecting withflow optimised housing Figure 062

- As combination check valve (KRV)
- As flow check valve (KRV)
- With test appliance for the prescribed function test of the check valve
- Completely stainless steel, resistant against aggressive water
- With self-lubricating EPDM lip seals that can be replaced under pressure as a maintenance-free spindle sealing
- Stagnant-zone-free
- DVGW-, SVGW-, KIWA- and soundproofing certificate
- Connection facility for all common piping systems

KEMPER regulating valves

KEMPER regulating valves reliably ensure the hydraulic compensation in complex sanitary installation systems. Made completely of stainless steel, in a multitude of function variants:

- Can be pre-adjusted and stopped
- Manual / static or automatic / thermal regulation



KEMPER 'Multi-Therm' automatic /thermal circulation regulating valve Figure 041

'Multi-Therm': 4 + 1 in the compact

- 1 Thermostatic regulating unit
- 2 Stop unit with mount for thermometer or measuring sensor
- 3 Movable emptying unit and G 3/4 hose connection
- 4 Measuring unit with thermometer or temperature sensor
- + Automatic thermal disinfection

KEMPER concealed valves 'UP-plus' flexible with mature technology

The widely assorted KEMPER 'UPplus' range gives planners and plumbers a free hand when selecting materials and designing, for function and assembly, coupling and connection technology. This versatility does not only offer a complete package of important benefits, but also pays off by saving costs in any installation: Flexibility for every wall and every trend. With pioneering technology.

KEMPER throttle valve manual / static circulation regulation valve

- Can be stopped without changing the presets
- With stop and drain for maintenance work
- with position display through adjustable bracket



KEMPER throttle-valve with preset Figure 078



KEMPER 'UP-plus' with permanently integrated press-fitting 'mapress' Figure 052 02

KEMPER 'UP-plus' with universal female thread Figure 052 10

Flexible in function and connection

complete package of important benefits, but also pays off by saving costs in any installation: Flexibility for every wall and every trend. With pioneering technology, KEMPER 'UP-plus' stainless steel valves can be stopped, regulated and preset. In the entire floor installation for cold, warm and circulation lines along with individual sanitary elements. Variable in the connection technology through universal female threads for all common piping systems and permanent press fit mapress.

Flexible in design

The 'UP-plus' is available with the original KEMPER handle or with closed detachable key element, protecting from unauthorised access. With the KEMPER adapter, you have a great variety of designs of operating handles made by leading brand manufacturers on top of that.



KEMPER original handle
Figure 590



KEMPER detachable key element
Figure 591

Flexible in assembly

Regardless of which installation depth 'UP- plus' is to be used in: With the shaft extension set and the facility for cutting to size right before tiling, 'UP-plus' can be adapted to any desired installation depth.



Extension set for 'UP-plus' Figure 599



Advantages at a glance

- With stop, regulation and presetting function
- Valve shaft and spindle extension made of high-grade plastic
- Variable installation depth up to 180 mm
- With pre-tiling protection and optionally with a set of fasteners for pre-wall installation
- Made entirely out of stainless steel, resistant against aggressive water
- With maintenance-free spindle
- Stagnant-zone-free
- DVGW-/ SVGW and soundproofing certificate



KEMPER valves for shipbuilding

Drinking water is a valuable and limited resource

That means it is exactly at high sea that drinking water hygiene needs to be complied with. Through a professional installation of the drinking water plant and the hydraulic compensation in the warm water system.

It is exactly here that the KEMPER hygiene system KHS starts. By using automatic circulation regulating valves with the corresponding monitoring and logging facilities in the warm water area.

And the use of flow distributors in the cold water area to prevent stagnation in seldom-used line sections.

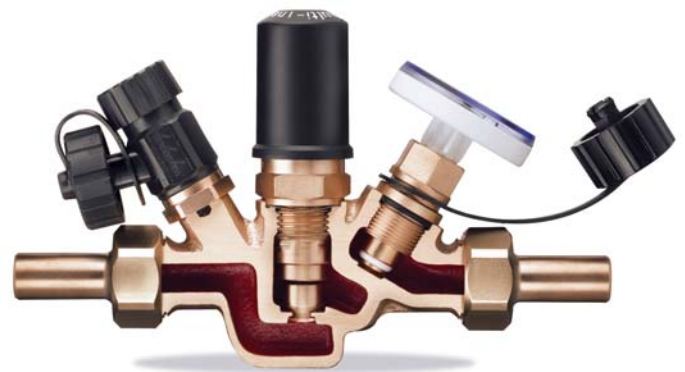

KEMPER Multi-Therm Figure 140

Individual components in KEMPER Hygiene System KHS



KEMPER industry valves

The application areas for our stop, safety and regulating valves in the industrial sector are highly versatile.

Whether safety valves such as system disconnectors in the chemical and pharmaceutical industry or, e.g., flange valves and sampling valves in apparatus engineering and plant manufacturing.

We offer a wide product range everywhere stopping is required in the nominal widths of DN 10 up to and including DN 250.

In the flange segment, one can select from among straight-seat valves, flow-optimised inclined-seat valves, membrane valves and up to flange sliders in various technologies, depending on the application. Sleeve valves as valves, sliders or ball valves are available in small dimensions.

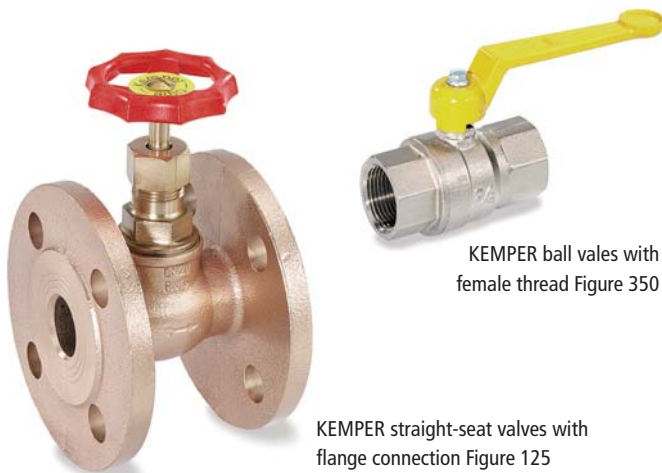
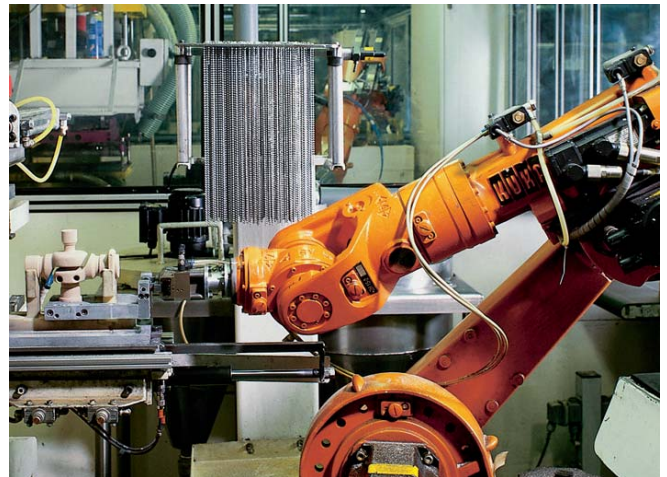

KEMPER ball valves with female thread Figure 350

KEMPER straight-seat valves with flange connection Figure 125



KEMPER 'Fill-Matic 4' heater filling combination BA Figure 365

With safety valves such as anti-pollution check-valve, pipe disconnectors and backflow preventers you protect the drinking water from process water exactly in industrial companies. We protect drinking water hygiene from DN 15 up to and including DN 150.

KEMPER 'Fill-Matic 4' heater filling combination BA Figure 365, steam valves in various versions, strainers and taps round off the range in various application fields.



KEMPER straight-seat anti-pollution check-valves with flange connection Figure 165



KEMPER tank filling and draining valves Figure 307



KEMPER straight-seat fine control valves for steam plants with female thread Figure 184



KEMPER insulating shells

Highest goal: Energy savings by insulating all valves

Insulation of pipelines and valves is prescribed by the legislator.

It is intended to reduce the global warming caused by humans and to attain sustainable handling of primary energy resources. These standards places requirements on heating, room air and warm water preparation plants. Furthermore, for cold-water conducting lines, insulation measures against condensation formation, frost and heating from outdoors are to be taken into consideration.

With insulating shells from KEMPER, you comply with the strictest requirements!

Energy savings with KEMPER insulating shells

With KEMPER insulating shells you will achieve a noticeable reduction in the primary energy demand of buildings. An economic benefit for you, a relief for the environment.

➤ **Note:**
Planning insulating shells across the board avoids subsequent insulation work.

To prevent subsequent and expensive insulation measures, it is best to include a suitable insulating shell for each valve in the material list during the project and tender phase.

KEMPER insulating shells

For rapid and economical insulation of KEMPER valves to prevent:

- Energy / heat loss
- Condensate formation

KEMPER universal insulating shells
Figure 471 10 for all KEMPER free-flow inclined valves



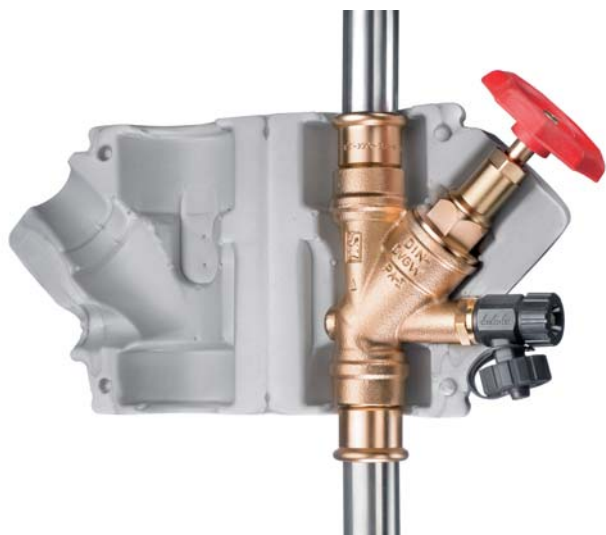

Insulating shells Figure 471 11 specifically for KEMPER ‚Multi-Therm‘ automatic circulation regulation valves

Insulating shells Figure 471 16 specially made for KEMPER concealed water meter combinations

Insulating shells Figure 471 14 specially made for KEMPER concealed ‚UP-plus‘ valves

- Made of PE material
- Building material class B1
- Temperature resistant up to 100 °C
- Thermal conductivity $\lambda = 0.035 \text{ W/mK}$
- No condensation
- Simple and quick assembly
- Diffusion resistant to bonding with common adhesives
- Can be securely locked with the supplied fastening clips

1
2
3
4
5
6
7
8
9
10
11
12
13

KEMPER employee development program: European-wide

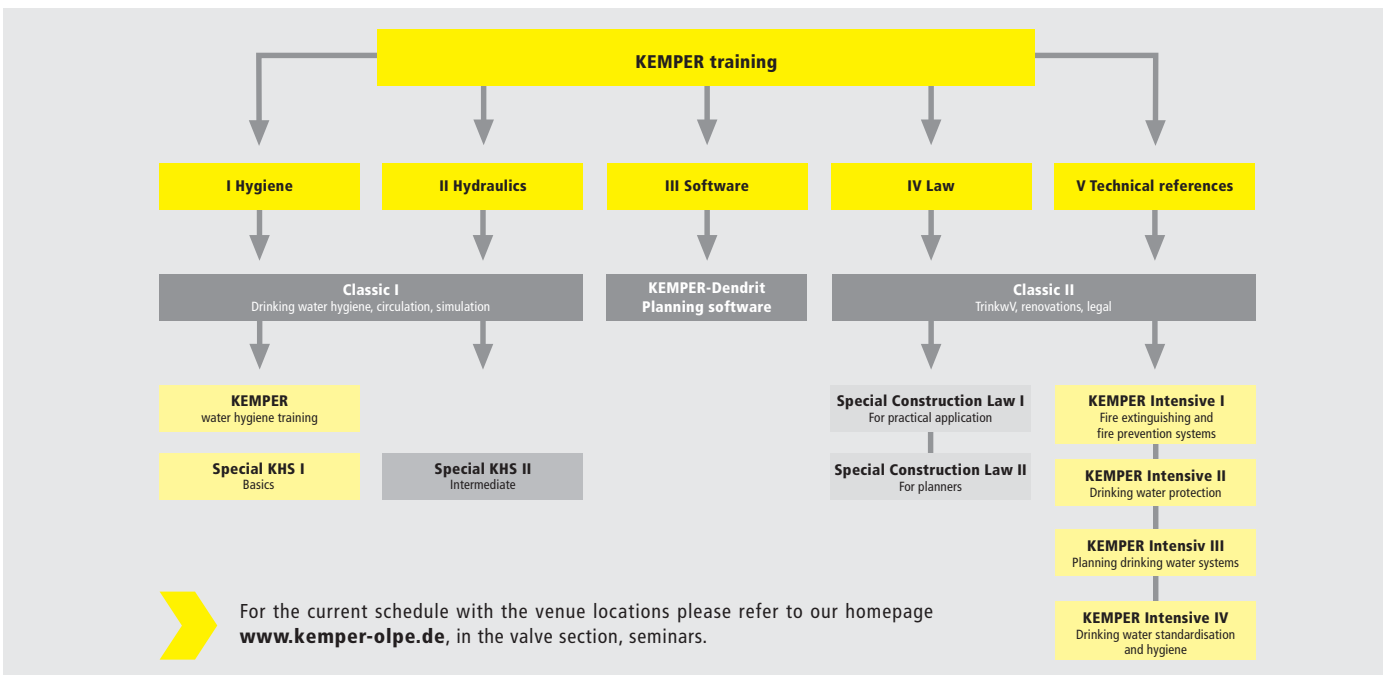



KEMPER contact

Contact persons - Backoffice

Team Export

Judith Frohne
Phone +49 (0) 27 61 89 12 43
Fax +49 (0) 27 61 89 14 07
jfrohne@kemper-olpe.de

Alexandra Kornaga
Phone +49 (0) 27 61 89 11 28
Fax +49 (0) 27 61 89 14 07
akornaga@kemper-olpe.de

Annika Alfes
Phone +49 (0) 27 61 89 14 37
Fax +49 (0) 27 61 89 14 07
aalfes@kemper-olpe.de

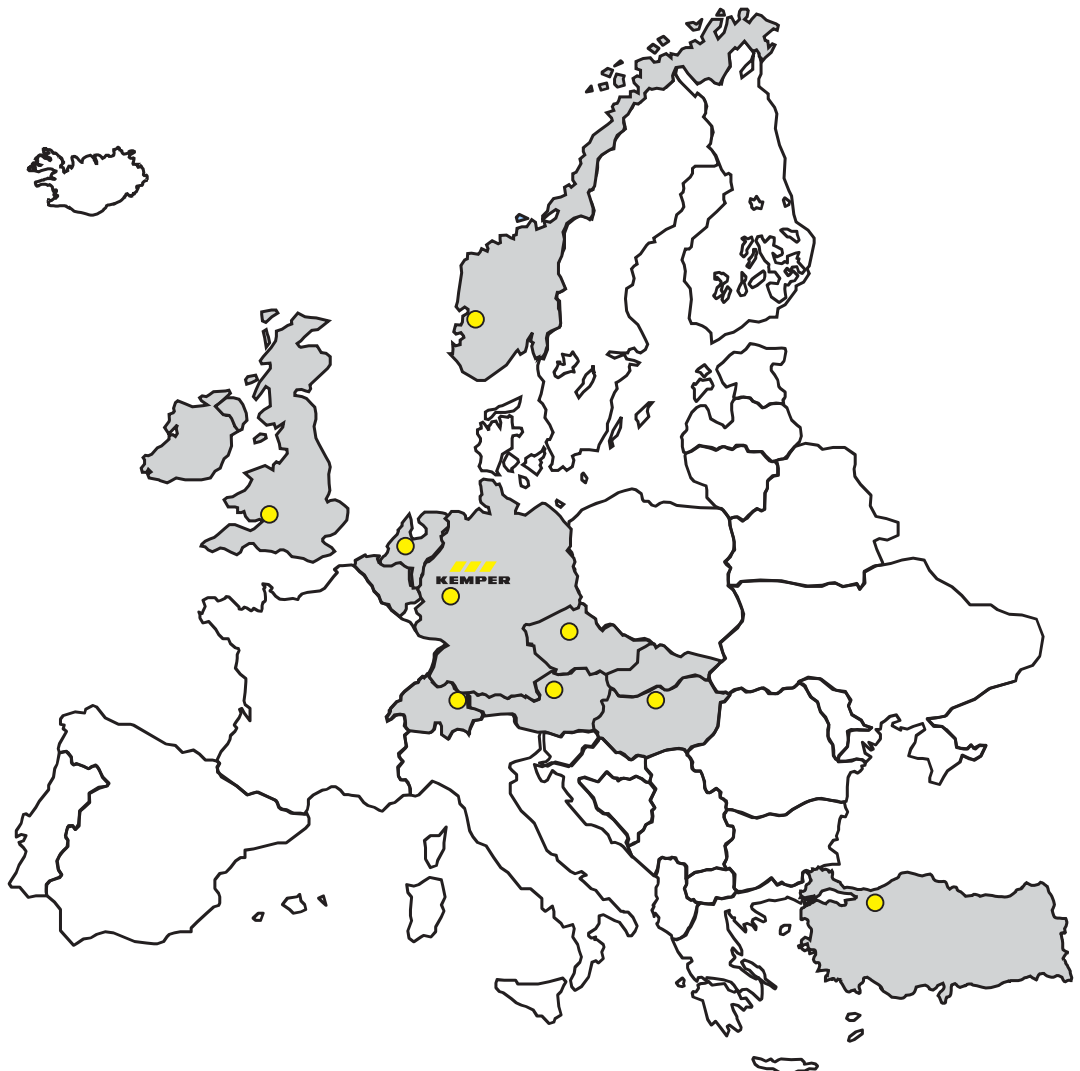



1

2

3

4

5

6

7

8

9

10

11

12

13

Export representations

Austria

August Stöttner
 (Sales management Austria)
 Wolfshütte 27
 A-4901 Ottwang
 Phone +43 (0) 7 67 62 07 20
 Mobile +43 (0) 67 67 55 61 56
 stoettner@ad-kemper-olpe.de
 Post code areas:
 4000-6000, 8700-9000

Great Britain, Ireland

Kemper Rhodes UK
 Basepoint Business Centre
 Oakfield close
 Tewkesbury
 Gloucestershire
 GL20 8SD
 England
 Phone +44 (0) 16 84 85 44 55
 Fax +44 (0) 16 84 85 44 56
 Mobil +44 (0) 77 64 85 98 88
 info@kemper-rhodes.co.uk

Switzerland

Kemper Armaturen AG
 Feldmoosstrasse 12
 CH-8853 Lachen
 Phone +41 (0) 55 241 26 22
 Fax +41 (0) 55 241 25 55
 schweiz@kemper-olpe.de

Luxemburg

Michael Wurm
 Schubertstraße 8
 57482 Wenden
 Phone +49 (0) 27 62 49 05 74
 Fax +49 (0) 27 62 49 05 35
 Mobile +49 (0) 17 16 75 06 61
 wurm@ad-kemper-olpe.de

Shanghai

Kemper Trading (Shanghai)
 Co., Ltd. Zhai Pin
 5th floor, China Merchants Tower
 161 LuJiaZui (E) Road, Pudong
 Shanghai 200120
 China
 Phone +86 021 587 53 53-118
 Fax +86 021 58 76 77 38
 zhaipin@kemper.sh.cn

Turkey

AVC Endüstriyel Ürünler Ltd.
 Ahmet Ergoz
 Can Sokak No: 7/B
 TR-34742 Kozyatağı Kadıköy - Istanbul
 Phone +90 (0) 216 384 43 67
 Fax +90 (0) 216 384 43 69
 Ahmet.Ergoz@Avc.Com.Tr

Belgium and Holland

Hans Donker
 Koeweistraat 7b
 NL-4181CD Waardenburg
 Phone +31 (0) 4 18 65 15 55
 Fax +31 (0) 4 18 65 25 55
 Mobile +31 (0) 6 43 04 41 30
 donker@ad-kemper-olpe.de

Luxemburg

Technical Consultant
 Jürgen Weinheimer
 Im Pfahlstück 2
 56332 Löff / Mosel
 Phone +49 (0) 26 05 8 49 95 21
 Fax +49 (0) 26 05 8 49 95 22
 Mobile +49 (0) 1 51 11 44 47 75
 weinheimer@ad-kemper-olpe.de

Singapore

Kemper Asia Pacific RO
 Raymond Yang Yu Fook
 Block 526, #20-120
 Bukit Batok Street 51
 Singapore 650526
 Phone +65 96 31 17 48
 Fax +65 66 18 47 33
 rayyang@kemper.per.sg

Hungary

Aquatherm-Hungaria Kft.
 Dévai György
 Dunalejaro 14
 H-1211 Budapest
 Phone +36 (0) 14 25 40 95
 Fax +36 (0) 14 27 12 33
 gyuri_devai@aquatherm.hu

Czech Republic / Slovakia

Kemper CZ - Jiří Hýsek
 BC Klamovka
 Plzeňská 155/113
 CZ-150 00 Praha 5
 Phone +42 (0) 2 55 73 96 10
 Fax +42 (0) 2 55 73 96 10
 Mobile +42 (0) 6 02 64 08 63
 jhysek@kemper-armatury.cz

Norway

Froster AS
 Lars Frost
 Sandviksveien 30
 N-5036 Bergen
 Phone +47 (0) 55 36 58 55
 Fax +47 (0) 55 21 51 60
 post@froster.no

United Arab Emirates

R.O.M.E Mechanical Regional
 Wolfgang Spies
 Office Middle East
 Jalza-Licence No.06579
 P.O. Box
 UAE-17372 Dubai
 Phone +971 48 81 05 02
 Fax +971 48 81 05 93
 kemper@rome-mechanical.com



Gebr. Kemper GmbH + Co. KG
Metallwerke
Harkortstraße 5 · D-57462 Olpe

Phone +49 27 61 - 8 91 - 0
Fax +49 27 61 - 8 91 - 1 76
info@kemper-olpe.de

KEMP 7000 06/09